



GarrettCom®

Industrial Networking at Its Best™

Magnum 6KM Mobile Ethernet Switch



Hardware Installation and User Guide

Magnum™ 6KM Mobile Ethernet Switch

Hardware Installation and User Guide

Part #: 84-00186Z (Rev. D)

Trademarks

GarrettCom is a registered trademark and **Magnum, Dymec, DynaStar, Personal Switch, Link-Loss-Learn, S-Ring, Convenient Switch** and **Converter Switch** are trademarks of GarrettCom, Inc.

Ethernet is a trademark of Xerox Corporation

NEBS is a trademark of Telcordia Technologies

UL is a registered trademark of Underwriters Laboratories

Important: The Magnum 6KM Mobile Ethernet Switch contains no user serviceable parts. Attempted service by unauthorized personnel shall render all warranties null and void. If problems are experienced with Magnum 6KM Switch products, consult Section 6, Troubleshooting.

Copyright © 2010 GarrettCom, Inc. All rights reserved. No part of this publication may be reproduced without prior written permission from GarrettCom, Inc.

Printed in the United States of America

GarrettCom, Inc. reserves the right to change specifications, performance characteristics and/or model offerings without notice.

Contacting GarrettCom, Inc

Please use the mailing address, phone and fax numbers and email address listed below:

GarrettCom, Inc.

47823 Westinghouse Dr.

Fremont, CA 94539-7437

Phone (510) 438-9071

Fax (510) 438-9072

Website: <http://www.GarrettCom.com>

Email: support@garrettcom.com

Federal Communications Commission
Radio Frequency Interference Statement

This equipment generates uses and can radiate frequency energy and if not installed and used properly in strict accordance with the manufacturer's instructions, may cause interference to radio communication. It has been tested and found to comply with the limits for a Class A computing device in accordance with the specifications in Subpart J of Part 15 of FCC rules, which are designed to provide reasonable protection against such interference when operated in a commercial environment. Operation of this equipment in a residential area is likely to cause interference, in which case the user, at their own expense, will be required to take whatever measures may be required to correct the interference.

Canadian Emissions Statement

This Class A digital apparatus meets all requirements of the Canadian Interference-Causing Equipment Regulations.

Cet appareil respecte toutes les exigences du Règlement sur le matériel du Canada. Cet appareil est Classe A.

CAUTION:

Disconnect All power before servicing.

Electrical Safety requirements:

1. This product is to be installed Only in Restricted Access Areas (Dedicated Equipment Rooms, Electrical Closets, or the like).
2. All products shall be installed with a readily accessible disconnect device in the building installation supply circuit to the product.
3. This product shall be provided with a maximum 10A DC Listed fuse or circuit breaker in the supply circuit when connected to a 48V centralized source.
4. The external power supply for DC units shall be Listed, Direct Plug In power unit, marked Class 2, or listed ITE Power Supply, marked LPS, which has suitably rated output voltage (i.e. 24VDC or 48VDC) and suitable rated output current.
5. Product does not contain user replaceable fuses. Any internal fuses can ONLY be replaced by GarrettCom personnel through the RMA process.

Table of Contents		Page
1.0	<u>SPECIFICATIONS</u>	1
1.1	Technical Specifications	1
1.2	Ordering Information	4
2.0	<u>INTRODUCTION</u>	6
2.1	Inspecting the Package and Product.....	6
2.2	Product Description - Magnum 6KM Mobile Ethernet Switch.....	7
2.2.1	Packet Prioritization, 802.1p QOS.....	8
2.2.2	Frame Buffering and Flow Control	8
2.3	Managed Network Software for Magnum 6KM	9
2.4	Features and Benefits.....	10
2.5	Applications	11
3.0	<u>INSTALLATION</u>	12
3.1	Locating Magnum 6KM Switches	12
3.2	Connecting Ethernet Media	13
3.2.1	Connecting Twisted Pair for 10/100Mb (CAT3, CAT5, UTP or STP).....	13
3.2.2	Connecting Twisted Pair for Gigabit (CAT5e or better, UTP or STP).....	14
3.2.3	Connecting <u>Single-Mode</u> Fiber Optic.....	15
3.2.4	Connecting Fiber Optic Cable to LC ports	15
3.3	DIN-Rail Mounting the Magnum 6KM	16
3.3.1	Mounting Dimensions for 6KM with metal brackets	16
3.4	Powering the Magnum DC 6KM Mobile Ethernet Switches	18
3.5	Alarm Contacts for monitoring internal power, and Software Traps	19
3.6	Connecting the Console Terminal to Magnum 6KM	20
3.6.1	M12 Console Port pin assignments.....	20
4.0	<u>OPERATION</u>	21
4.1	Switching Functionality	21
4.2	Auto-Cross(MDIX) and Auto-negotiation, for M12 ports	22
4.3	Flow-control, IEEE 802.3x standard.....	23
4.4	Power Budget Calculations for 6KM Modules with Fiber Media.....	24
5.0	<u>Magnum 6KM Mobile Ethernet Switch Port Modules</u>	24
5.1	6KM Modules	24
5.1.1	6KM Module LED designations.....	25
5.1.2	6KM4-4M12, 4 x 10/100Mb M12 (Slot C)	27
5.1.3	P6KM4-4M12, 4 x PoE M12 (Slot C)	28
5.1.4	6KM4-4MLC, 4 x Multimode LC (Slot C).....	29
5.1.5	6KM4-4SLC, 6KM4-4SLCL, 4 x Singlemode LC (Slot C)	29
5.1.6	6KM4-2MLC2RJ, 2 x Multimode LC, 2 x 10/100Mb M12 (Slot C).....	30
5.1.7	6KM4-2SLC2RJ, 6KM4-2SLCL2RJ,.....	30
5.1.8	6KM-2GM12, 2 x Gigabit M12 (Slot B)	31
5.1.9	6KM-2GMLC, 2 x Gigabit Multimode LC (Slot B).....	31
5.1.10	6KM-2GSLC, 6KM-2GSLCL, 2 x Gigabit Singlemode LC (Slot B).....	31
6.0	<u>TROUBLESHOOTING</u>	32
6.1	Before Calling for Assistance	32
6.2	When Calling for Assistance.....	32
6.3	Return Material Authorization (RMA) Procedure	33
6.4	Shipping and Packaging Information.....	34

<u>APPENDIX A: WARRANTY INFORMATION</u>	34
<u>APPENDIX B: DC Single Source Power Input</u>	35
<u>APPENDIX C: DC Dual Source Power Input</u>	38
<u>APPENDIX D: AC Power Input</u>	41

Revisions:

Rev. A 07/10:	Initial Release
Rev. B 10/10:	Updated Electrical requirements (pg. ii), replaced 14mil conformal coating with 8mil, updated Wall-mount brackets.
Rev. C 11/10:	Added Power installation certified installer note to Appendix B and Appendix C. Added external power connector information to pages 36, 40 and 41.
Rev. D 04/11:	Added modules 6KM4-2MLC2RJ, 6KM4-2SLC2RJ, 6KM4-2SLCL2RJ

1.0 SPECIFICATIONS**1.1 Technical Specifications****Performance**

Filtering / Forwarding Rate:

Ethernet (10Mb): 14,880 pps

Fast Ethernet (100Mb): 148,800 pps

Gigabit Ethernet (1000Mb): 1,488,000 pps

Switching Processing Type: Store and Forward with IEEE 802.3x full-duplex flow-control, non-blocking

Data Rate: 10Mbps, 100Mbps and 1000Mbps

Address Table Capacity: 8K node, self-learning with address aging

Packet buffer size: 128 KB total

Latency: 6 μ s + packet time max. (TX-TX, TX-FX, FX-FX, TX-G, G-G)

Throughput with 8 10/100 and 2Glink max.- 4.17M pps (Transmit)

Network Standards and Compliance, hardware

Ethernet V1.0/V2.0 IEEE 802.3: 10BASE-T,

IEEE 802.3u: 100Base-TX, 100BASE-FX

IEEE 802.3z: 1000BASE-X Ethernet (Auto-negotiation)

IEEE 802.3ab: 1000BASE-X Ethernet

IEEE 802.1p: Priority protocol

IEEE 802.1d: Spanning tree protocol

IEEE 802.1w: Rapid Spanning tree protocol

IEEE 802.1q: VLAN Tagging

IEEE 802.3x: Flow Control

IEEE 802.3ad: Link Aggregation (Trunking)

IEEE 802.1x: Port based Network access control

IEEE 802.3af: Power over Ethernet

Maximum 10 Mbps Ethernet Segment Lengths

Unshielded twisted pair	- 100 m (328 ft)
Shielded twisted pair	- 150 m (492 ft)
10BASE-FL multi-mode fiber optic	- 2 km (6,562 ft)
10BASE-FL single-mode fiber optic	- 10 km (32,810 ft)

Maximum Standard Fast Ethernet Segment Lengths:

10BASE-T (CAT 3, 4, 5 UTP)	- 100 m (328 ft)
100BASE-TX (CAT 5 UTP)	- 100 m (328 ft)
Shielded twisted pair	- 150 m (492 ft)
100BASE-FX, half-duplex, multi-mode	- 412 m (1350 ft)
100BASE-FX, full-duplex, multi-mode	- 2.0 km (6,562 ft)
100BASE-FX, half-duplex, single-mode	- 412 m (1350 ft)
100BASE-FX, full-duplex, single-mode	- 20.0 km (66K ft)
100BASE-FX, full-duplex, Long Reach	- 40.0 km (122K ft)

Maximum Standard Gigabit Ethernet Segment Lengths:

1000BASE-T (CAT5e or higher is recommended)	- 100m (328 ft)
1000BASE-SX, full-duplex, multi-mode (62.5 μ m cable)	- 220m
1000BASE-SX, full-duplex, multi-mode (50 μ m cable)	- 550m
1000BASE-LX, full-duplex, multi-mode (50, 62.5 μ m cable)	- 550m
1000BASE-LX, full-duplex, single-mode (9 μ m cable)	- 5km

1000BASE-ZX, full duplex, single-mode (9µm cable) - >70km

Copper 10/100Mb connector types supported:

Copper Port, M12-type (4-pin, D-key coded)

Copper 1000Mb connector types supported:

Copper Port, M12-type (8-pin, A-key coded)

Fiber Multi-mode connector types supported:

Fiber Port, LC-type, SFF Fiber multi-mode

Fiber Single-mode connector types supported:

Fiber Port, LC-type, SFF Fiber single-mode

LEDs: Per Port (one set at the port)

(see section 5.1.1 for detailed LED configurations)

Operating Environment

Ambient Temperature:

-40° to 195° F (-40° to 85°C) for IEC 60068 Type Test short term rating

-40° to 140° F (-40° to 60°C) for UL60950 and Component Parts rating

Storage Temperature: -60° to 210°F (-50° to 100°C)

Ambient Relative Humidity: 5% to 95% (non-condensing)

Altitude: -200 to 13,000 ft. (-60 to 4000m)

Conformal Coating (humidity protection) optional: Request quote

Alarm Relay Contacts

One NC indicating internal power, one NC software controllable, signals are accessed via M12 connector pins, "Alarm" port

Packaging

Enclosure: High strength cold rolled steel

Dimensions: 9.0 in H x 2.2 in W x 6.0 in D (in vertical mounting position)

22.7 cm H x 5.5 cm W x 15.2 cm D

Cooling method: Convection, enclosed steel case used as a heat sink, no fans

Weight: 2.1 lbs. (0.95 kg)

IP Rating: 52

DC Power Supply (Internal, floating ground)

DC Power Connector: RD24 locking, male

12VDC Power Input nominal (range 10 to 15VDC)

24VDC Power Input nominal (range 18 to 36VDC)

48VDC Power Input nominal (range 36 to 60VDC)

110VDC Power Input nominal (range 77 to 137VDC)

125VDC Power Input nominal (range 88 to 150VDC)

250VDC Power Input nominal (range 160 to 300VDC)

Power Input for PoE: add up to 15 watts per PoE port to the base unit power draw

AC Power Supply (Internal)

AC Power Connector: RD24 locking, male
100-240VAC Power Input, 47 to 63 Hz (auto-ranging)

Power Consumption:

15 watts Max. (for a fully loaded fiber model with 2Gb)
10 watts Max. (for 8 port copper and 100Mb fiber model)

Dual –Source DC Power Input (Optional)

A Dual-Source option is available for the 12VDC, 24VDC, –48VDC, 110VDC, 125VDC and 250VDC models. This provides for continuity of operation when either of the DC input sources is interrupted. See Appendices B and C.

The Dual-Source power input connector is configured: “ +A, -A, -B, +B ”

Management Console connector

M12 interface, female, see details in Section 3.6

6KM Mounting:

Vertical or horizontal mounting normal. Suitable for wall or DIN-Rail mounting

Agency Approvals and Standards Compliance:

UL listed (UL60950), cUL, CE, Emissions meet FCC Part 15 Class A
Shock: IEC 61373, IEC 60068-2-27
Vibration: IEC 61373, IEC 60068-2-6 FC
EN50155 and EN50121-4 Railway Applications Standards
NEBS Level 3 and ETSI Compliant
IEEE 1613 Class 2 Environmental Standard for Electric Power Substations
See also **Note for Power Substations** in Section 3.2.1, 3.6.1, and 5.1.2
IEC 61850 EMC and Operating Conditions Class C for Power Substations
NEMA TS-2 and TEES for DC-powered and PoE-powered traffic control equipment
DNV for shipboard and offshore applications

Warranty: Three years Made in USA

Email info@GarrettCom.com for additional information.

1.2 Ordering Information

<u>MODEL</u>	<u>DESCRIPTION</u>
Magnum 6KM-110VDC:	Magnum 6KM Mobile Ethernet Switch, base unit with four 10/100 M12 copper ports in slot A. Up to 4 100Mb fiber ports or up to four more 10/100 M12 copper ports (or combinations) may also be configured, and up to two Gb ports. Heavy duty metal case, IP52 for environmental protection, no fans. Power Input is 110VDC nominal (range 77-137VDC)
For licensed managed networks software (MNS-6K and MNS-6K-SECURE) including GUIs for ease-of-use and industry-leading security features, see separate data sheets.	
Magnum 6KM-12VDC:	Same as 6KM-110VDC except the power input is 12VDC
Magnum 6KM-24VDC:	Same as 6KM-110VDC except the power input is 24VDC
Magnum 6KM-48VDC:	Same as 6KM-110VDC except the power input is -48VDC
Magnum 6KMP-48VDC:	PoE, same as 6KM-48VDC except the four 10/100 ports are PoE-enabled, data pairs
Magnum 6KM-125VDC:	Same as 6KM-110VDC except the power input is 125VDC
Magnum 6KM-250VDC:	Same as 6KM-110VDC except the power input is 250VDC
Magnum 6KM-AC:	Same as 6KM-110VDC except the power input is AC 100 to 240VAC, 47 to 63 Hz

Please use this URL: for the complete Configuration Guide for the Magnum 6KM.
http://garrettcom.com/techsupport/insertion_guides/6kmcg.pdf

Configuration Options: (see following pages)

Each Magnum 6KM base unit may be configured with a choice of 1 modular slot (Slot C) and 1 modular slot, Gigabit ports (Slot B) in addition to the fixed M12 ports in Slot A.

Following modules can be configured in Slot C only**(Slot C is 10/100 M12 or 100Mb Fiber only)****Magnum 6KM (Slot C) Port Modules:**

6KM4-4M12	adds four 10/100Mb M12 copper ports
P6KM4-4M12	adds four PoE 10/100Mb M12 copper ports
6KM4-4MLC	adds four MM 2Km 100Mb LC fiber ports
6KM4-4SLC	adds four SM 20Km 100Mb LC fiber ports
6KM4-4SLCL	adds four SM 40Km 100Mb LC fiber ports
6KM4-2MLC2RJ	adds two MM 2Km 100Mb LC fiber ports and two 10/100Mb M12 copper ports
6KM4-2SLC2RJ	adds two SM 20Km 100Mb LC fiber ports and two 10/100Mb M12 copper ports
6KM4-2SLCL2RJ	adds two SM 40Km 100Mb LC fiber ports and two 10/100Mb M12 copper ports

Following modules can be configured in Slot B only**Magnum 6KM (Slot B) Gigabit Port Modules:**

6KM-2GM12	adds two auto-negotiating 10/100/1000Mb M12 copper ports
6KM-2GMLC	adds two MM 2Km 1000Mb LC fiber ports
6KM-2GSLC	adds two SM 20Km 1000Mb LC fiber ports
6KM-2GSLCL	adds two SM 40Km 1000Mb LC fiber ports

MM= Multi-mode fiber

SM= Single-mode fiber

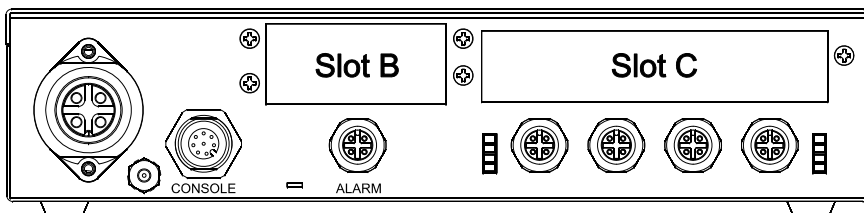
**Options and Extras:**

S-RING-Key: S-Ring Redundancy Manager licensed software for redundant ring management. One S-Ring key is for licensed use one 6K-managed self healing Ring.

CONSOLE-CBLM: Console attachment cable. Cable is constructed with an M12 to DB-9 for connection to a PC. Console cable includes a DB-9 to USB conversion cable.

DIN-RAIL-6KM: Din-Rail mount for a secure vertical mount, with screws for 6KM

DUAL-SRC: Two separate power inputs (12/24/48/110/125 or 250VDC)

CONFORM05-CRM: Conformal coating, heavy duty silicone at 5 mil thickness, for interior PCBs, PS and modules (for moisture protection)

CONFORM08-CRM: Conformal coating, heavy duty silicone at 8 mil thickness, for interior PCBs, PS and modules (for corrosion protection, oil and gas industry typically)

MNS-6K License- MNS-6K managed software is pre-loaded from the factory

2.0 INTRODUCTION

2.1 Inspecting the Package and Product

Examine the shipping container for obvious damage prior to installing this product; notify the carrier of any damage that you believe occurred during shipment or delivery. Inspect the contents of this package for any signs of damage and ensure that the items listed below are included.

This package should contain:

- 1 Magnum 6KM Mobile Ethernet Switch, base unit
(configured with user-selected port module options installed)
- 2 Set of two metal vertical mounting brackets, with screws to the case
- 1 6KM Installation and User Guide (this manual)

Remove the items from the shipping container. Be sure to keep the shipping container should you need to re-ship the unit at a later date.

In the event there are items missing or damaged, contact the party from whom you purchased the product. If the unit needs to be returned, please use the original shipping container if possible. Refer to Section 6, Troubleshooting, for specific return procedures.

2.2 Product Description - Magnum 6KM Mobile Ethernet Switch

Magnum™ 6KM Mobile Ethernet Switches provide configurability in Heavy Duty mobile networking applications. The high performance Magnum 6KM base unit comes with four 10/100 M12 copper ports (either regular or PoE). Up to four 100Mb fiber ports or up to four more 10/100 M12 copper ports, or combinations, may also be configured. Two Gigabit ports may also be configured with 10/100/1000 M12 copper ports or LC-type fiber ports.

M12 military-style port connectors for copper Ethernet ports (instead of RJ45 connectors) make the 6KM distinctive, and withstand the vibration and shock found in mobile applications. To connect the M12 port cables, simply align the keyed female connector to the 6KM male connector and twist the threaded lock to secure.



Magnum 6KM comes with the best-of-breed MNS-6K managed networks software. (MNS-6K-SECURE optional) See the datasheet for more information at <http://www.garrettcom.com/techsupport/software/datasheets/mns6kds.pdf>

Magnum 6KMs are ideal for mobile networks such as on passenger railways, public service and emergency vehicles, shipboard, mining equipment, and military vehicles. Applications include in-carriage networking of IP-enabled infotainment systems, security and surveillance systems, and mobile network devices on trains, light rail and busses, as well as passenger accommodation technology in a variety of mobile scenarios. The 6KM Mobile Ethernet Switch has the appropriate agency approvals, including EN50155 and EN50121-4 Railway Applications Standards, IEC61373 for shock and vibration, NEMA TS-2 for transportation systems outdoors, and DNV certification for shipboard and other marine applications. Additional certifications include third-party UL testing for safety, NEBS L3 compliance, and IEC 61850 & IEEE 1613 for power utilities.

The 6KM's sealed metal case serves as a heat sink, enabling it to operate in the harshest mobile environments and achieves high EMI noise immunity. The 6KM is available with optional Conformal Coating for moisture resistance and is rated IP52 for protection against dust and dirt. The 6KM can be configured with the user's choice of power input, including DC at 12V, 24V, 48V, 110V, 125V, 250VDC, and Dual-Source for each, as well as universal AC.

The 6KM managed switches also provides a PoE option via power –inside PoE base unit (6KMP-48VDC) on Slot A and allows the users to utilize up to 4-ports of PoE or 8-ports with additional PoE module (P6KM4-4M12) on Slot C to support 802.3af Powered devices. See details for PoE base unit in sec 5.1.11. The Power Sourcing Equipment (PSE) is fully compatible with Powered Devices (PD)(e.g wireless access points, IP phones) that comply with the IEEE 802.3af PoE standard. The PoE switch ports have an auto-sensing algorithm, so that they provide power only to 802.3af, PoE end devices. **PoE is managed by a multi-stage handshake to protect equipment from damage and to manage power budgets** . The PoE ports will discontinue supplying power when the PoE powered devices are disconnected. This feature supports the 802.3af PoE PSE standard for over-current protection, under-current detection, and fault protection.

High performance features include non-blocking unicast traffic speed on all ports and 802.1p QoS Traffic Prioritization. Magnum 6KM switches are “plug-and-play” and are designed for use in connecting edge devices such as PLCs, IEDs and PoE video cameras with upstream switches and routers where a mix of bursty data traffic and priority streaming traffic for video surveillance and cell-tower applications are present.

Magnum 6KM Mobile Ethernet Switches have heavy-duty steel cases and are readily available with standard Industrial grade DC power. Internal AC power and DC power input types may be 12V, 24V, 48V, 110, 125V, 250V and dual source DC input is optional on the 6KM.

Alarm Relay contacts provided on each Magnum 6KM Switch monitor the hardware and software through traps, providing a record of any losses of power signals and other user- defined software events. See Section 3.5 for details.

2.2.1 Packet Prioritization, 802.1p QOS

Quality of Service means providing consistent predictable data delivery to users from datagram paths that go all across a network. As a LAN device, the Magnum 6KM can do its part to prevent any QOS degradation while it is handling Ethernet traffic through its ports and buffers.

The Magnum 6KM switching hardware supports the IEEE 802.1p standard and fulfills its role in support of QOS, giving packet processing priority to priority tagged packets according to the 802.1p standard. In addition to hardware support for QOS, the MNS software (R2) supports two priority queues that can be shared across the eight levels of defined packet priorities for application-specific priority control by the user through software configuration settings.

2.2.2 Frame Buffering and Flow Control

Magnum 6KM's are store-and-forward switches. Each frame (or packet) is loaded into the Switch's memory and inspected before forwarding can occur. This technique ensures that all forwarded frames are of a valid length and have the correct CRC, i.e., are good packets. This eliminates the propagation of bad packets, enabling all of the available bandwidth to be used for valid information.

When the Magnum 6KM Switch detects that its free buffer queue space is low, the Switch sends industry standard (full-duplex only) PAUSE packets out to the devices sending it packets to cause “flow control”. This tells the sending devices to temporarily stop sending traffic, which allows the traffic to catch-up without dropping packets. Then, normal packet buffering and processing resumes. This flow-control sequence occurs in a small fraction of a second and is transparent to an observer.

Another feature implemented in the Magnum 6KM Switches is a collision-based flow-control mechanism (when operating at half-duplex only). When the Switch detects that its free buffer queue space is low, the Switch prevents more frames from entering by forcing a collision signal on all receiving half-duplex ports in order to stop incoming traffic.

2.3 Managed Network Software for Magnum 6KM

Magnum 6KM comes with licensed MNS-6K software or MNS-6K-SECURE, which allow the user to configure the Magnum 6KM as a Managed Switch and implements security features and other software enabled features.

(NOTE: Magnum 6KM managed switch will work with MNS-6K Rel v4.1.9 firmware or higher version only, or MNS-6K-SECURE v14.1.9 firmware or higher version only. Using any earlier MNS-6K versions will not support the 6KM hardware)

For additional information about MNS-6K, see the Magnum MNS-6K **Software User guide** in pdf format, a separate document normally accessible via your web-browser, at <ftp://ftp.garrettcom.com/> or FTP client program at <ftp.GarrettCom.com> using

```
user : m6kuser  
password : m6kuser
```

All MNS-6K software information, and the documentation related to MNS-6K and MNS-6K-SECURE software, can be accessed at GarrettCom’s FTP site.

Alternatively, for the latest documentation and information, or needed GarrettCom’s MIBs for SNMP, look for the Magnum MNS-6K info **at** www.GarrettCom.com/techsupport/index.htm#software .

For interactive training software which shows basic and advanced info about the Magnum MNS-6K management software and for a useful tool for first time users, visit [Magnum MNS-6K Operator Training](#).

You may also email: info@GarrettCom.com for further information.

2.4 Features and Benefits

■ M12 Copper connections

Magnum 6KM Switches utilize M12 connectors to withstand shock and vibration. Ideally suited for the harshest of mobile applications.

■ Managed switching for high performance Ethernet LANs

Magnum 6KM Switches provide unicast non-blocking (all ports can run at full speed at once) performance with standard Managed Network Software. They are typically used in LAN traffic centers with up to 8 100Mb +2 Gigabit ports for backbone connections, where managed network services are desired.

■ Switching services includes 802.1p QoS packet prioritization

The Magnum 6KM switching hardware supports QoS, giving packet processing priority to priority tagged packets according to the IEEE 802.1p standard. For port- and application-specific priorities of data, the QoS software may be configured.

■ Fiber Ports Built-In

Magnum 6KM Mobile Ethernet Switches are designed to naturally include fiber ports, and support mixes of multi-mode, single-mode, 100Mb and 1000Mb speed; full- and half-duplex; and classic Small Form Factor (SFF) fiber connectors.

■ Relay Contacts for monitoring internal power and user-defined software events

Two Alarm Relay contacts monitor basic operations. One is for hardware, and will signal loss of power internally. The other is software controlled and will signal user-defined software events such as a security violation or an S-Ring fault condition.

■ Panel mounting for efficient convection cooling, no fans, extended temperature

Mounting brackets for vertical or horizontal mounting are included. DIN-Rail mounting hardware is optional.

■ All types of power input, 12, 24, 48, 110, 125, 250VDC and AC

The 6KM can be configured with the user's choice of DC power supplies: 12V and 24V for factory floor, 48V for tariffed carrier field facilities and for PoE-powered applications such as IP video surveillance, 110V for railways and 125V or 250V for substations. An internal AC power supply may also be chosen, universal AC for use worldwide.

■ Heavy-duty design for Industrial Ethernet and extended temperature operation

Fiber ports take more power than copper ports, but the Magnum 6KM design provides for this with heavy-duty components. The ambient temperature dual-rating is 60°C per UL methods, and 85°C per IEC type test methods.

■ MNS-6K licensed Management Software

Managed Networks Software (MNS) basic version, combined with a Magnum 6K-Series Switch, provides power and efficiency in a managed Ethernet platform. A full range of industry-standard software functions in the MNS-6K software product enables the versatile Magnum 6K Switches to perform efficiently in a wide range of managed LAN applications, including redundant topologies.

- **MNS-6K-SECURE (optional, for extra security)**
Magnum MNS-6K-SECURE software is designed for those customers demanding extra security in their networks. MNS-6K-SECURE is an optional item--licensed per switch. All of the features in regular MNS-6K are included, plus extra security.
- **S-Ring and Link Loss Learn for economical high availability using ring topology**
S-Ring combined with the Link-Loss-Learn feature provides reliable fast recovery of a fault in an economical ring topology combining unmanaged and managed switches.
- **RSTP-2004 for rings and meshes, fastest fault recovery, interoperability**
RSTP-2004 provides reliable fast recovery from a fault in a redundant LAN, which may include Magnum switches and routers as well as other vendors industry-standard-RSTP products. Redundant topologies may include rings, dual-rings, and complex meshes.



2.5 Applications

Magnum 6KM Mobile Ethernet Switches offer high performance, configurability and high availability. They provide the flexibility of 100Mbps fiber and copper ports as well as dual Gigabit (1000Mb) ports, with industry-standard LAN management software.

Magnum 6KMs are ideal for mobile networks such as on passenger railways, public service and emergency vehicles, shipboard, mining equipment, and military vehicles. Applications include in-carriage networking of IP-enabled infotainment systems, security and surveillance systems, and mobile network devices on trains, light rail and busses, as well as passenger accommodation technology in a variety of mobile scenarios. The 6KM Mobile Ethernet Switch has the appropriate agency approvals, including EN50155 and EN50121-4 Railway Applications Standards, IEC61373 for shock and vibration, NEMA TS-2 for transportation systems outdoors, and DNV certification for shipboard and other marine applications. Additional certifications include third-party UL testing for safety, NEBS L3 compliance, and IEC 61850 & IEEE 1613 for power utilities.

The mixed-media modular capability is ideal for industrial applications where existing Ethernet LAN network cabling must be accommodated. The fiber-built-in media capability is ideal for integrating future-proof fiber cabling into the LAN structure.

3.0 INSTALLATION

Before installing the equipment, it is necessary to take the following precautions:

- 1.) If the equipment is mounted in an enclosed or multiple rack assembly, the steady-state long-term environmental temperature around the equipment must be less than or equal to 60°C.
- 2.) If the equipment is mounted in an enclosed or multiple rack assembly, adequate airflow must be maintained for proper and safe operation.
- 3.) If the equipment is mounted in an enclosed or multiple rack system, placement of the equipment must not overload or load unevenly the rack system.
- 4.) If the equipment is mounted in an enclosed or multiple rack assembly, verify the equipment's power requirements to prevent overloading of the building/s electrical circuits.
- 5.) If the equipment is mounted in an enclosed or multiple rack assembly verify that the equipment has a reliable and uncompromised earthing path.

This section describes installation of the Magnum 6KM Switches, as well as connection of the various Ethernet media types.

3.1 Locating Magnum 6KM Switches

For vertical DIN-Rail mounting, see Section 3.3

For vertical panel mounting and wall mounting, see Section 3.3.1

For DC power input data, see Appendix B. For Dual Source, see Appendix C

The rugged metal case of the Magnum 6KM will normally protect it from accidental damage in a lab or workplace setting. Maintain an open view of the front to visually monitor the status LEDs. Keep an open area around the unit so that cooling can occur from convection while the unit is in operation. The 6KM has no fans, so it is silent when in operation. Internal electronics use the case as a heat sink, so the unit may normally be quite warm to the touch.

3.2 Connecting Ethernet Media

The Magnum 6KM Switches are specifically designed to support standard Ethernet media types within a single Switch unit. (See Section 5.1 for a description of the Modules)

The various media types supported along with the corresponding IEEE 802.3, 802.3D, 802.3u, 802.3AB and 802.3z standards and connector types are as follows:

<u>Media</u>	<u>IEEE Standard</u>	<u>Connector</u>
Twisted Pair (CAT3 or 5)	10BASE-T	M12
Twisted Pair (CAT5)	100BASE-TX	M12
Twisted pair (CAT5E or CAT6)	1000BASE-T	M12
Fiber (Multi-mode)	10BASE-FL	LC
Fiber (Multi-mode)	100BASE-FX	LC
Fiber (Single-mode)	100BASE-FX	LC
Fiber (Multi-mode)	1000BASE-SX	LC
Fiber (Multi-mode, Single-mode)	1000BASE-LX	LC
Fiber (Single-mode)	1000BASE-ZX	LC

See http://www.garrettcom.com/techsupport/power_budget.pdf for Power budget calculations, to find fiber cable distance information.

3.2.1 Connecting Twisted Pair for 10/100Mb (CAT3, CAT5, UTP or STP)

The M12 ports of the Magnum 6KM can be connected to the following two media types: 100BASE-TX and 10BASE-T. CAT 5 cables should be used when making 100BASE-TX connections. When the ports are used as 10BASE-T ports, CAT 3 may be used. In either case, the maximum distance for unshielded twisted pair cabling is 100 meters (328 ft).

NOTE : *It is recommended that high quality CAT. 5 cable be used whenever possible in order to provide flexibility in a mixed-speed network, since 10/100 copper switched ports are auto-sensing for either 10 and 100Mb/s.*

The following procedure describes how to connect a 10BASE-T or 100BASE-TX twisted pair segment to the M12 port. The procedure is the same for both unshielded and shielded twisted pair cables.

1. Using standard twisted pair cable with M12, 4-pin connector at 6KM side, insert the end of the cable with an M12 plug into the M12 connector of the port. (unshielded or shielded cables and wiring may be used)
2. Connect the other end of the cable to the corresponding device
3. Use the LINK/A LED to ensure proper connectivity by noting that the LED will be illuminated when the unit is powered and proper connection is established.

NOTE: for Power Substations: In support of the IEEE 1613 Class 2 standard, GCI advises that, for substation applications, the M12 ports are intended for connectivity to other communication equipment such as routers or telecommunication multiplexers installed in close proximity (i.e., less than 2 meters or 6.5ft) to the 6KM. It is not recommended to use these ports in substation applications to interface to field devices across distances which could produce high (greater than 2500V) levels of ground potential rise (GPR) during line-to-ground fault conditions. The 6KM passes the 1613 specifications for zero packet loss with fiber ports & with M12 ports used as indicated here.

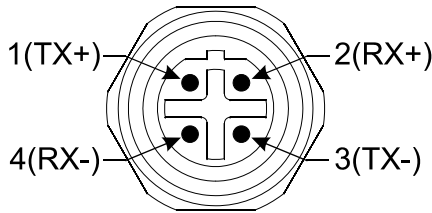

Fig 3.2.1a 10/100Mb 4-Pin D-Coded M12 pin configuration

3.2.2 Connecting Twisted Pair for Gigabit (CAT5e or better, UTP or STP)

The M12 Gigabit ports of the Magnum 6KM can be connected to the media types, 1000BASE-T or CAT 5E or better 100-ohm UTP or shielded twisted pair (STP) balanced cable. The CAT 5E or better 100-ohm UTP or shielded twisted pair (STP) balanced cable is recommended to use when making 1000BASE-TX connections. In either case, the max distance for unshielded twisted pair cabling is 100 meters (328 ft).

The following procedure describes how to connect a 1000BASE-T twisted pair segment to the M12 port. The procedure is the same for both unshielded and shielded twisted pair cables.

1. 1000BASE-T connections require that all four pairs or wires be connected. Using CAT5e or better twisted pair cable with M12, 8-pin connector at 6KM side, insert the end of the cable with an M12 plug into the M12 connector of the port.
(unshielded or shielded cables and wiring may be used)
2. Connect the other end of the cable to the corresponding device
3. Use the LINK LED to ensure proper connectivity by noting that the LED will be illuminated when the unit is powered and proper connection is established.

Pair 1	Pin 6 = TX+ (MDI3+)
	Pin 4 = TX- (MDI3-)
Pair 2	Pin 1 = TX- (MDI0+)
	Pin 7 = TX+ (MDI0-)
Pair 3	Pin 5 = RX+ (MDI1-)
	Pin 8 = RX- (MDI1+)
Pair 4	Pin 2 = RX+ (MDI2-)
	Pin 3 = RX- (MDI2+)

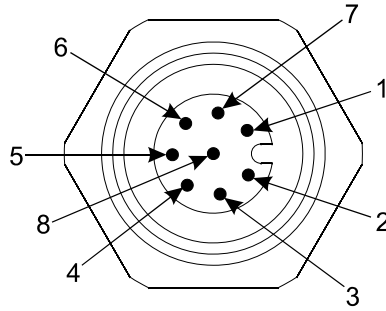

Fig 3.2.2a 1000Mb 8-Pin A-Coded M12 pin configuration

3.2.3 Connecting Single-Mode Fiber Optic

When using single-mode fiber cable, be sure to use single-mode fiber port connectors. Single-mode fiber cable has a smaller diameter than multi-mode fiber cable (9/125 microns for single-mode, 50/125 or 62.5/125 microns for multi-mode where xx/xx are the diameters of the core and the core plus the cladding respectively). Single-mode fiber allows full bandwidth at longer distances, up to 70km with the single-mode LC.

3.2.4 Connecting Fiber Optic Cable to LC ports

1. Before connecting the fiber optic cable, remove the protective dust caps from the tips of the connectors. Save these dust caps for future use.
2. Wipe clean the ends of the dual connectors with a soft cloth or lint-free lens tissue dampened in alcohol. Make certain the connectors are clean before connecting.
3. Connect the Transmit (TX) port on the Magnum 6KM to the Receive (RX) port of the remote device. Connect the Receive (RX) port on the 6KM to the Transmit (TX) port of the remote device.

While connecting fiber media to LC connectors, simply snap on the two square male connectors into the LC female jacks of the Fiber connector until it clicks and secures.

The LINK LED on the front of the 6KM will illuminate and turn Green, when a proper connection has been established at both ends (and when power is ON in the unit). If LINK is not lit or OFF after cable connection, the normal cause is improper cable polarity. Swap the fiber cables at the 6KM connector and also check the connectivity on the target device to remedy this situation.

Reconfigure or reboot both of the devices if required.

If connected properly, you can check via (MNS-6K) software for verifying the validity of SFF Gigabit ports.

3.3 DIN-Rail Mounting the Magnum 6KM



The Magnum 6KM is designed for use in a “factory floor” industrial environment. It is available with an optional DIN-Rail bracket to mount it securely in a metal factory floor enclosure, maintained vertically for proper convection cooling of the unit. The Magnum 6KM requires one DIN-Rail bracket for secure mounting. See a 6KM viewed from the bottom, at the rear, showing the DIN Rail in place.

The DIN Rail bracket is mounted to the bottom of the 6KM unit, as shown. Four threaded holes are provided on the bottom of the 6KM for DIN-Rail mounting purposes. The required four screws are included with the DIN-Rail bracket, and are no. 4-40 x 9/32 PHIL. PAN Head. The rail clip is spring-loaded with a pull-up latch at the top for easy “snap-on” attachment and removal.

To install the 6KM with the DIN-Rail bracket installed, hold the 6KM in the side vertical position with the bottom out, and with the top moved in toward the DIN-Rail. Position the DIN bracket over the top of the DIN-Rail. Then, snap the bracket into holding position by moving the bottom of the 6KM inwards to a vertical position. The DIN-Rail bracket is heavy duty, and will hold the 6KM securely in position, even with cabling attached to the unit.

To release the 6KM from the DIN-Rail mounting, push the spring loaded slide down until the unit release from the DIN rail, disengaging the DIN rail bracket from the DIN rail. Once the bottom of the 6KM is rotated out, the DIN-Rail bracket is not engaged and the 6KM can be moved up and out, free of the DIN-Rail mounting.

The DIN-Rail mounting bracket is optional and needs to be ordered as separate items, e.g Model # DIN-RAIL-6KL.

3.3.1 Mounting Dimensions for 6KM with metal brackets

Each Mangum 6KM is supplied with metal mounting brackets and screws to mount the unit securely on a panel or wall. It is recommended to mount the 6KM vertically in one of the two mounting positions available, as shown below, for proper cooling and long-life reliability. It is also advisable to mount the unit with space for air movement around the top and the sides, typically a minimum of 1 inch.

Note: The metal brackets supplied, hold the back of the 6KM unit out from the panel or wall behind it, creating a rear space of about 1/8 inch or 3mm. This allows air circulation and cooling of the rear part of the case.

For best cooling of the 6KM, attach the metal brackets to metal (rather than wood or plastic). Attaching to metal helps conduct heat away from the 6KM through the metal brackets and into the metal support structure.

Since the 6KM has special internal thermal techniques to move the heat generated by the electronic components inside into the case, the case may be quite warm to the touch during normal operation.

Fig 3.3.1a

Panel / Wall Mounting:

The unit is mounted using the brackets as shown in the illustration above. The spacing for the mounting screws into the supporting wall or panel is a rectangle 3.10 x 9.78 inches (7.9 x 24.8 cm) center-to-center.

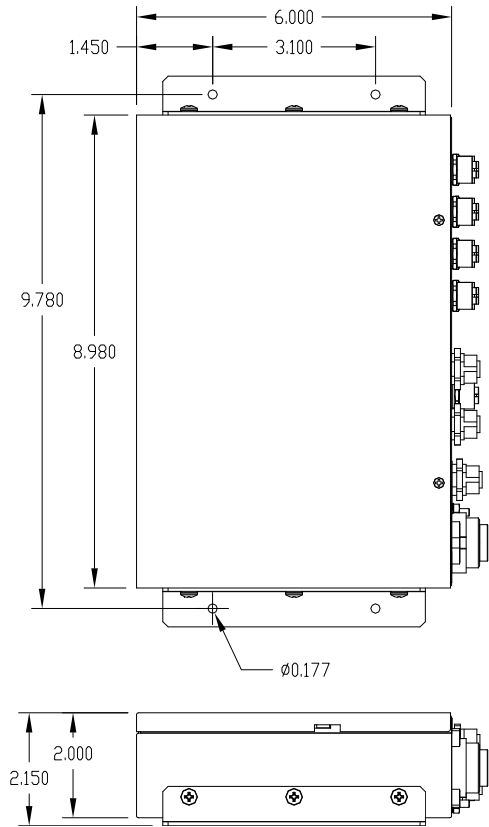

3.4 Powering the Magnum DC 6KM Mobile Ethernet Switches

The DC internal power supply supports installation environments where the DC voltage is from 10 to 300 volts, depending on the 6KM model selected. The power consumption will range from about 10 up to 15 watts, depending on the port quantity and types in the configuration. When connecting the Ethernet cabling, there is no need to power down the unit. Individual cable segments can be connected or disconnected without concern for power-related problems or damage to the unit.

DC power input options are available to suit the 6KM Mobile Ethernet Switches to special high-availability communications and/or heavy industrial-grade applications, including:

- * 12VDC, -48VDC, 24VDC, 110VDC, 125VDC and 250VDC with single DC input,
- * 12VDC, -48VDC, 24VDC, 110VDC, 125VDC and 250VDC with dual DC input
- * AC input with internal power supply

(see Section 1.2, for Ordering Information)



Fig 3.4a
Single DC power input

Power input connection made with RD 24 4-position (**male**) locking connector, +, -, NC, NC (Not connected)
(See Appendix B for more information)



Fig 3.4b
Dual-Source DC power input

Power input connection made with RD 24 4-position (**male**) locking connector, A+,A -, B-, B+
(See Appendix C for more information)



Fig 3.4c
AC power input

Power input connection made with RD 24 4-position (**male**) locking connector, +, -, GND, NC (Not connected)
(See Appendix D for more information)

3.5 Alarm Contacts for monitoring internal power, and Software Traps

The Alarm Contacts feature, standard on Magnum 6KM's, provides two Form Normally Closed (NC) contacts to which the user can attach two sets of status monitoring wires at the green terminal block.

The first NC Alarm Contact is a "Software Alarm" (labeled S/W), operated by user settings in the MNS-6K software. The user can disable the Software Alarm feature with a software configuration command if desired. When the Software Alarm is enabled, the Form C Normally Closed (NC) contact is held close during normal software operation. A user-defined software malfunction, such as an SNMP Trap or a Software Security violation or an S-Ring Fault, causes the contact to open and thus triggers an alarm in the user's monitoring system

The second NC Alarm Contact is held closed when there is power on the main board inside of the Switch. This provides a "Hardware Alarm" (labeled H/W) because the NC contacts will open when internal power is lost, either from an external power down condition or by the failure of the power supply inside of the Magnum Switch.

Useful info. about Alarm contacts:

1. There is a four pin M12 (D-key coded) provided next to the Console port.
2. The top two pins (1,2) are software operated
3. The bottom two pins (3,4) are hardware operated
4. These are both NC (normally closed) relays
5. The switch's software operation needs to be enabled and set to get the Alarm traps. For detailed information about the Software Alarm and software control of SNMP alarm traps, please reference the Magnum MNS-6K Software User Manual.

The Alarm Contacts are on the front left area (next to the Console port) of the Magnum 6KM unit (labeled as ALARM).

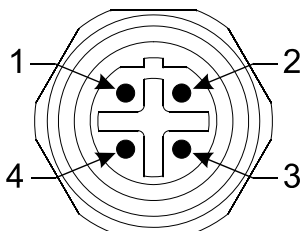

Fig 3.5a Alarm Contacts:

(1,2) are software operated
(3,4) are hardware operated

3.6 Connecting the Console Terminal to Magnum 6KM

The 6KM Console port, used to access the managed switch's software, has an 8-pin M12 (male) port. A console cable with the mating M12 (female) port and both a DB-9 and / or a USB connector is available for purchase from GarrettCom.

The model# is: **CONSOLE-CBLM**

Note: For a detailed description of the 6KM's Managed Network Software (MNS-6K) and the Magnum 6KM Switch Configuration information, please refer to [Magnum 6K Software Manual](#) available on GarrettCom's FTP site. It is also available on GCT's website at:

http://www.garrettcom.com/techsupport/sw_downloads.htm

To build your own console cable, the Console port pin-out is described below.

3.6.1 M12 Console Port pin assignments

(8-pin M12 A-coded, female, on 6KM switch)

M12 (6KM Console Port connector)

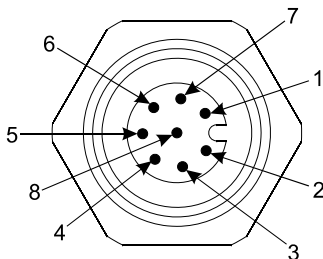

Pin	Signal	Description
1	open	not used
2	TXD	Transmit Data (output)
3	RXD	Receive Data (input)
4	open	not used
5	GND	Ground
6	open	not used
7	open	not used
8	open	not used

The above provided information enables a managed station (a PC or Console terminal) to connect directly to the switch.

NOTE for Power Substations: *In support of the IEEE 1613 Class 2 standard, GCI advises that, for substation applications, the (M12) console ports are intended for temporary connectivity to other equipment such as PCs. Since the console port connection is temporary, it is excluded from IEEE 1613 packet-loss testing per the 1613 standard-defined test procedure.*

4.0 OPERATION

This chapter describes the functions and operation of the Magnum 6KM Switch.

4.1 Switching Functionality

A Magnum 6KM provides switched connectivity at Ethernet wire-speed among all of its ports. The Magnum 6KM supports 10/100Mbps for copper media and 100Mb separate traffic domains for fiber ports to maximize bandwidth utilization and network performance. All ports can communicate to all other ports in a Magnum 6KM, but local traffic on a port will not consume any of the bandwidth on any other port.

The Magnum 6KM units are plug-and-play devices. There is no software configuring necessary to be done for basic operation at installation or for maintenance. There is an optional Half / Full duplex mode and 10Mbps or 100Mbps selection for the switched ports which must be configured through MNS software per unit as per the requirement. The internal functions of both are described below.

Filtering and Forwarding

Each time a packet arrives on one of the switched ports, the decision is taken to either filter or to forward the packet. Packets whose source and destination addresses are on the same port segment will be filtered, constraining them to that one port and relieving the rest of the network from having to process them. A packet whose destination address is on another port segment will be forwarded to the appropriate port, and will not be sent to the other ports where it is not needed. Traffic needed for maintaining the uninterrupted operation of the network (such as occasional multi-cast packets) is forwarded to all ports.

The Magnum 6KM Switches operate in the store-and-forward switching mode, which eliminates bad packets and enables peak performance to be achieved when there is heavy traffic on the network.

Address Learning

All Magnum 6KM units have address table capacities of 8K node addresses suitable for use in larger networks. They are self-learning, so as nodes are added, removed or moved from one segment to another, the 6KM Switch automatically keeps up with node locations.

An address-aging algorithm causes least-used addresses to fall out in favor for frequently-used addresses. To reset the address buffer, cycle power down-and-up.

4.2 Auto-Cross(MDIX) and Auto-negotiation, for M12 ports

The M12 ports independently support auto-cross (MDI or MDIX) in auto-negotiation mode and will work properly with all the other connected devices with RJ-45 ports whether they support Auto-negotiation (e.g 10Mb Hub, media converter) or fixed mode at 10Mb or 100Mb Half/Full Duplex(managed switch) or not. No cross-over cable is required while using the 6KM's copper port to other devices. Operation is according to the IEEE 802.3u standard.

The Managed 6KM's Fast Ethernet copper ports can be set for either fixed 100Mb speed or for 10/100 F/H N-way auto-negotiation per the IEEE802.3u standard. The selection is made via MNS software. The factory default setting is for auto-negotiation. At 10Mb or 100Mb-fixed speed, the user may select half- or full-duplex mode by MNS Software for each M12 port separately. For detail information **See Section 2.3 of this manual for information to access the "6K-MNS Software user guide"**

One frequently-used application for the Managed Magnum 6KM Switch copper ports is to connect one of them using a fiber media converter to another Switch in the network backbone, or to some other remote 100Mb device. In this case, it is desirable to operate the fiber link at 100Mb speed, and at either half- or full duplex mode depending on the capabilities of the remote device. Standard commercially available Fast Ethernet media converters mostly do not support auto-negotiation properly, and require that the switched port to which they are connected be at the 100Mb fixed speed. Attachments to a 10/100 auto-negotiation port typically will not work properly. The 6KM Switch's M12 ports handle this situation by configuring the ports as per desired through MNS software port settings and can check the port status of each port after the change.

When Magnum 6KM (M12) copper ports are set for auto-negotiation and are connected to another auto-negotiating device, there are 4 different speed and F/H modes possible depending on what the other device supports. These are: (1) 100Mb full-duplex, (2) 100Mb half-duplex, (3) 10 Mb full-duplex and (4) 10 Mb half-duplex. The auto-negotiation logic will attempt to operate in descending order and will normally arrive at the highest order mode that both devices can support at that time. (Since auto-negotiation is potentially an externally controlled process, the original "highest order mode" result can change at any time depending on network changes that may occur). If the device at the other end is not an auto-negotiating device, the 6KM's M12 ports will try to detect its idle signal to determine 10 or 100 speed, and will default to half-duplex at that speed per the IEEE standard.

General information -

Auto-negotiation per-port for 802.3u-compliant switches occurs when:

-- the devices at both ends of the cable are capable of operation at either 10Mb or 100Mb speed and/or in full- or half-duplex mode, and can send/receive auto-negotiation pulses, and . . .

- the second of the two connected devices is powered up*, i.e., when LINK is established for a port, or
- the LINK is re-established on a port after being lost temporarily.
- **NOTE** – *Some NIC cards only auto-negotiate when the computer system that they are in is powered. These are exceptions to the “negotiate at LINK – enabled” rule above, but may be occasionally encountered.*

When operating in 100Mb half-duplex mode, cable distances and hop-counts may be limited within that collision domain. The Path Delay Value (PDV) bit-times must account for all devices and cable lengths within that domain. For Magnum 6KM Fast Ethernet switched ports operating at 100Mb half-duplex, the bit time delay is 50BT.

4.3 Flow-control, IEEE 802.3x standard

Magnum 6KM Switches incorporate a flow-control mechanism for Full-Duplex mode. The purpose of flow-control is to reduce the risk of data loss if a long burst of activity causes the switch to save frames until its buffer memory is full. This is most likely to occur when data is moving from a 100Mb port to a 10 Mb port and the 10Mb port is unable to keep up. It can also occur when multiple 100Mb ports are attempting to transmit to one 100Mb port, and in other protracted heavy traffic situations.

Magnum 6KM Switches implement the 802.3x flow control (non-blocking) on Full-Duplex ports, which provides for a “PAUSE” packet to be transmitted to the sender when the packet buffer is nearly filled and there is danger of lost packets. The transmitting device is commanded to stop transmitting into the 6KM Switch port for sufficient time to let the Switch reduce the buffer space used. When the available free-buffer queue increases, the Switch will send a “RESUME” packet to tell the transmitter to start sending the packets. Of course, the transmitting device must also support the 802.3x flow control standard in order to communicate properly during normal operation.

Note: When in Half-Duplex mode, the 6KM Switch implements a back-pressure algorithm on 10/100 Mb ports for flow control. That is, the switch prevents frames from entering the device by forcing a collision indication on the half-duplex ports that are receiving. This temporary “collision” delay allows the available buffer space to improve as the switch catches up with the traffic flow.

4.4 Power Budget Calculations for 6KM Modules with Fiber Media

Receiver Sensitivity and Transmitter Power are the parameters necessary to compute the power budget. To calculate the power budget of different fiber media installations using Magnum products, the following equations should be used:

$$\text{OPB (Optical Power Budget)} = P_T(\text{min}) - P_R(\text{min})$$

where P_T = Transmitter Output Power, and P_R = Receiver Sensitivity

Worst case OPB = OPB - 1dB(for LED aging) - 1dB(for insertion loss)

Worst case distance = {Worst case OPB, in dB} / [Cable Loss, in dB/Km]

where the "Cable Loss" for 62.5/125 and 50/125 μ m (M.m) is 2.8 dB/km,

and the "Cable Loss" for 100/140 (Multi-mode) is 3.3 dB/km,

and the "Cable Loss" for 9/125 (Single-mode) is 0.5 dB/km

and the "Cable Loss" for 9/125 (Single-mode) is 0.4 dB/km (LX25)

and the "Cable Loss" for 9/125 (Single-mode) is 0.25 dB/km (ZX40)

and the "Cable Loss" for 9/125 (Single-mode) is 0.2 dB/km (ZX70)

See http://www.garrettcom.com/techsupport/power_budget.pdf for more information on Power budget calculations

5.0 Magnum 6KM Mobile Ethernet Switch Port Modules

This chapter describes each Port Module (PM), including appearance, functionality, and status displays.

5.1 6KM Modules

An important feature of the Magnum 6KM is the use of Port Modules for flexible mixed-media connectivity to M12 copper and fiber media. The first four ports (1,2,3 & 4) of the Magnum 6KM Switches are fixed M12 copper ports with dual-speed 10/100Mbps auto-negotiating capability. Additionally the switch can accept up to two Port Modules to provide the user with up to 6 additional ports (10 total) providing a wide selection of Ethernet copper and fiber media connections with 10, 100 and 1000Mbps capability and up to 70km.

Note: The 6KM Port modules are not identical to the port modules used in other 6K products such as the 6KL, 6KQ, 6K32s 6K25e and 6K16V. For information about other 6K products, please see the applicable manual. For a list of 6KM Port Modules, refer to Section 1.2

Each 6KM Port Module (PM) is individually described in the following sections.

5.1.1 6KM Module LED designations

PWR LED= ON, when Power is being supplied to the unit.

M12 4-pin D-coded (10/100Mb) 1 LED per port

Link/A LED:

ON (10/100Mb) = LINK established

BLINKING = ACTIVITY

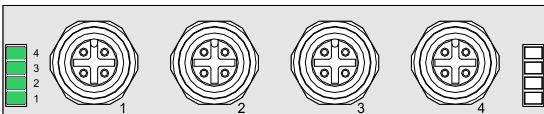

M12 PoE 4-pin D-coded (10/100Mb) 1 LED per port

ON (PoE) = PoE device detected

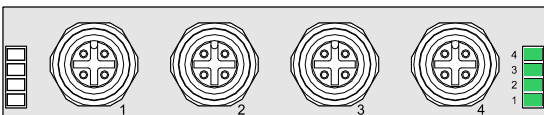

M12 8-pin A-coded (1000Mb) 2 Led per port

ON (1000Mb) = LINK established (top LED)

ON (10Mb) = LINK established (bottom LED)

ON (100Mb) = LINK established (both LED)

BLINKING = ACTIVITY

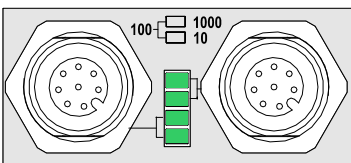

LC (100Mb) Fiber port, 2 LED per port

L/A LED:

ON = LINK established

BLINKING = ACTIVITY

F/H LED:

ON = Full Duplex

OFF = Half Duplex

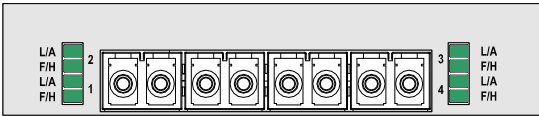

LC (1000Mb) Fiber port, 1 LED per port

Link/A LED:

ON = LINK established

BLINKING = ACTIVITY

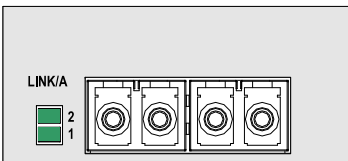

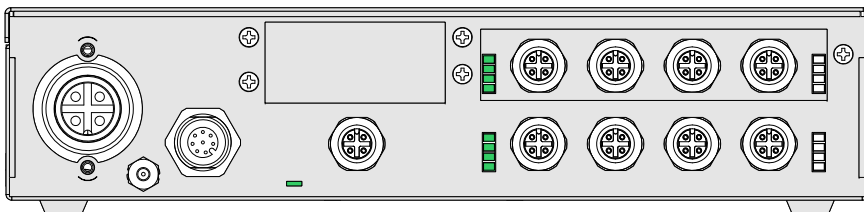
5.1.2 6KM4-4M12, 4 x 10/100Mb M12 (Slot C)

The 6KM4-4M12 4-port Copper module provides four 10/100Mb switched M12 ports. The 10/100Mb switched ports normally (as a default setting) are independently N-way auto-negotiating and auto-crossover (MDIX) for operation at 10 or 100Mb speed in full- or half-duplex mode. (i.e., each independently selects a mode and speed to match the device at the other end of the twisted pair cable). (for auto-negotiation and MDIX details, see Section 4.2 in this 6KM User Guide).

On the model 6KM4-4M12 module, there is one LED for each port. The Link/A LED indicates Link “ready for operation” for that port when lit. The A (Activity) LED indicates receiving Activity on that port when blinking. A twisted pair cable must be connected into an M12 port and the Link indicator for that port must be ON (indicating there is a powered-up device at the other end of the cable) in order for a Link LED to provide valid indications of operating conditions on that port.

Using the 6K (MNS-6K or MNS-6K-SECURE) management software, the user may disable auto-negotiation and fix the desired operation of each M12 port. The user may select 10Mb or 100Mb speed and full- or half-duplex mode per-port as per user requirements. (See Magnum MNS-6K Software Manual for additional info)

NOTE: for Power Substations: *In support of the IEEE 1613 Class 2 standard, GCI advises that, for substation applications, the M12 ports are intended for connectivity to other communication equipment such as routers or telecommunication multiplexers installed in close proximity (i.e., less than 2 meters or 6.5ft) to the 6KM. It is not recommended to use these ports in substation applications to interface to field devices across distances which could produce high (greater than 2500V) levels of ground potential rise (GPR) during line-to-ground fault conditions. The 6KM passes the 1613 specifications for zero packet loss with fiber ports and with M12 ports used as indicated here.*

5.1.3 P6KM4-4M12, 4 x PoE M12 (Slot C)

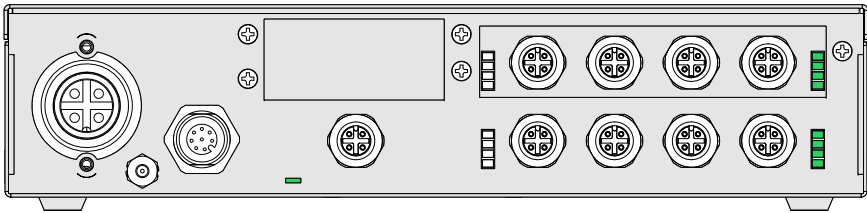

The 6KM is available with the option of having PoE capabilities on the four M12 ports in slot C. This is used in conjunction with 6KMP-48VDC to add an additional four PoE ports to the existing four PoE ports in slot A.

The PoE (Power-over-Ethernet) M12 ports are similar to regular M12 ports, except they have the capability of providing power on each port to power up attached PD devices, per the IEEE802.3af PoE standard. The power-pass-through PoE ports are dependent upon the -48VDC input power to supply the PD power for these M12 (10/100) ports. Each port supplies up to 15watts to power attached PoE PD devices.

The LEDs on the PoE ports are slightly different compared to regular (non-PoE) M12 ports. When the PoE port is in use, the PoE LED is ON when connected properly to an IEEE 803.af compliant PD device on that port. When non-PoE devices are connected, the PoE LED is OFF. Operation of Ethernet data traffic is not affected by PoE.

PoE LEDs Summary

- For PoE devices, each M12 PoE port supports only 802.3af compliant devices. The PoE LED is ON when the attached PD is drawing power from the port. The power is supplied on the data pairs, per IEEE802.3af PoE standard.
- For non-PoE devices connected, the PoE port will act as a normal M12 port and the PoE LED is OFF. No power is sent out from the port.
- The PoE ports in Magnum 6K's with 48VDC power input act as a pass-through, so the 48VDC power input source to the Magnum 6KM must be strong enough to provide power to the 6K switch and to all 4-M12 ports with PD devices connected (up to 15 watts per PoE port).

In the case where the 48VDC power is not internally connected to the POE port pins and no power is coming to the PoE ports for some reason, all the PoE port LEDs are ON simultaneously to indicate a trouble condition. The ports will still operate properly for data traffic to non-PoE devices.

5.1.4 6KM4-4MLC, 4 x Multimode LC (Slot C)

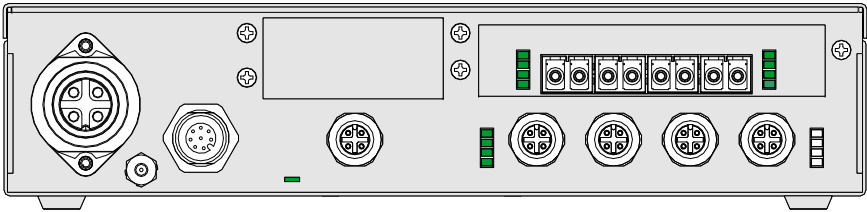

The 6KM4-4MLC 4-port Fiber module provides four 100Mb Multimode LC Fiber ports.

The 6KM4-4MLC fiber ports are Small Form Factor (SFF) LC Multimode connectors used primarily in 100Mbps fiber-to-the-desktop links. When installed in a Magnum 6KM Series Switch, it supports fiber optic cable distances up to the IEEE-standard 100Mbps distance limits, i.e., typically 2km at full-duplex and 412m at half-duplex.

The compact size of the LC Connector reduces the size of wiring panels in wiring closets while providing the advantage of “future-proof” fiber optic technology.

The cable end is a “plug-in” connector with both fiber strands terminated in one housing that cannot be improperly inserted. Each port has a Link/Activity (L/A) LED indicating proper connectivity (Link) with the remote device when lit and blinking (Activity), indicating packets being received and Full/Half Duplex (F/H) LED indicating Full Duplex (ON) and Half Duplex (OFF).

5.1.5 6KM4-4SLC, 6KM4-4SLCL, 4 x Singlemode LC (Slot C)

The 6KM4-4SLC 4-port Fiber module provides four 100Mb Singlemode LC Fiber ports, supporting distances up to 20km. This module provides the same functions as the Multimode version (see Section 5.1.4 for more details).

The 6KM4-4SLCL 4-port Fiber module provides four 100Mb Singlemode LC (Long Reach) Fiber ports, supporting distances up to 40km. This module provides the same functions as the Multimode version (see Section 5.1.4 for more details).

5.1.6 6KM4-2MLC2RJ, 2 x Multimode LC, 2 x 10/100Mb M12 (Slot C)

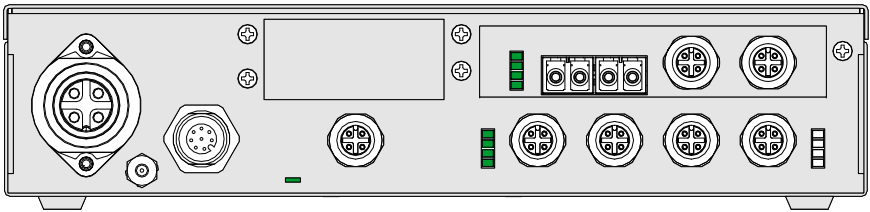

The 6KM4-2MLC2RJ 4-port Fiber/Copper module provides two 100Mb Multimode LC Fiber ports and two 10/100Mb M12 copper ports.

The 6KM4-2MLC2RJ fiber ports are Small Form Factor (SFF) LC Multimode connectors used primarily in 100Mbps fiber-to-the-desktop links. When installed in a Magnum 6KM Series Switch, it supports fiber optic cable distances up to the IEEE-standard 100Mbps distance limits, i.e., typically 2km at full-duplex and 412m at half-duplex.

The 6KM4-2MLC2RJ copper ports provide two 10/100Mb switched M12 ports. The 10/100Mb switched ports normally (as a default setting) are independently N-way auto-negotiating and auto-crossover (MDIX) for operation at 10 or 100Mb speed in full- or half-duplex mode. (i.e., each independently selects a mode and speed to match the device at the other end of the twisted pair cable).

Each port has a Link/Activity (L/A) LED indicating proper connectivity (Link) with the remote device when lit and blinking (Activity), indicating packets being received.

5.1.7 6KM4-2SLC2RJ, 6KM4-2SLCL2RJ, 2 x Singlemode LC, 2 x 10/100Mb M12 (Slot C)

The 6KM4-2SLC2RJ 4-port Fiber/Copper module provides two 100Mb Singlemode LC Fiber ports, supporting distances up to 20km and two 10/100Mb M12 copper ports. This module provides the same functions as the Multimode version (see Section 5.1.6 for more details).

The 6KM4-2SLCL2RJ 4-port Fiber/Copper module provides two 100Mb Singlemode LC Fiber ports, supporting distances up to 40km and two 10/100Mb M12 copper ports. This module provides the same functions as the Multimode version (see Section 5.1.6 for more details).

5.1.8 6KM-2GM12, 2 x Gigabit M12 (Slot B)

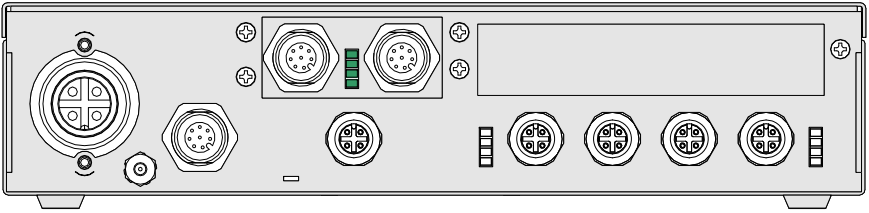

The 6KM-2GM12 2-port Copper Gigabit module provides two fixed 10/100/1000Mb M12 ports in slot B.

There are two LEDs provided for each Gigabit port. Each Copper Gigabit port has LEDs that indicate 10, 100 and 1000Mbps speed (set to AUTO by default).

5.1.9 6KM-2GMLC, 2 x Gigabit Multimode LC (Slot B)

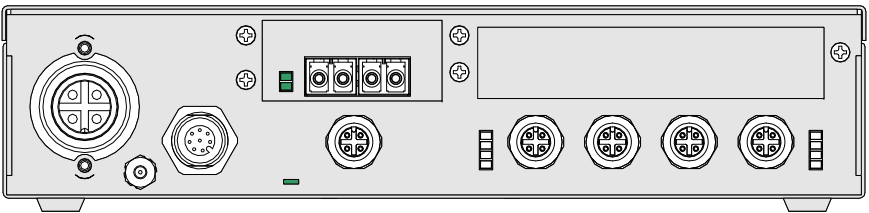

The 6KM-2GMLC 2-port Fiber Gigabit module provides two LC Multimode Gigabit ports capable of distances up to 2km.

The 1000Mb Gigabit fiber-port module on the Magnum 6KM are normally set (factory default) to operate at AUTO mode for best fiber distance and performance. Each port has a Link/Activity (Link/A) LED indicating proper connectivity (Link) with the remote device when lit and blinking (Activity), indicating packets being received.

5.1.10 6KM-2GSLC, 6KM-2GSLCL, 2 x Gigabit Singlemode LC (Slot B)

The 6KM-2GSLC 2-port Fiber Gigabit module provides two LC Singlemode Gigabit ports capable of distances up to 20km. (See section 5.1.9 for more details)

The 6KM-2GSLCL 2-port Fiber Gigabit module provides two LC Singlemode Gigabit ports capable of distances up to 40km. (See section 5.1.9 for more details)

6.0 TROUBLESHOOTING

All Magnum Ethernet products are designed to provide reliability and consistently high performance in all network environments. The installation of a Magnum 6KM Switch is a straight forward procedure. The operation is also straightforward and is discussed in Section 4.0 of this 6KM User Guide.

Should problems develop during installation or operation, this section is intended to help locate, identify and correct these types of problems. Please follow the suggestions listed below prior to contacting your supplier. However, if you are unsure of the procedures described in this section or if the Magnum 6KM Switch is not performing as expected, do not attempt to repair the unit; instead contact your supplier for assistance or contact GarrettCom Customer Support.

6.1 Before Calling for Assistance

1. If difficulty is encountered when installing or operating the unit, refer back to the Installation Section of the applicable chapter of this manual. Also check to make sure that the various components of the network are interoperable.
2. Check the cables and connectors to ensure that they have been properly connected and the cables/wires have not been crimped or in some way impaired during installation. (About 90% of network downtime can be attributed to wiring and connector problems.)
3. Make sure that power is properly attached to each Magnum 6KM Switch unit. Use the PWR LEDs to verify each unit is receiving power.
4. If the problem is isolated to a network device other than the Magnum 6KM Switch product, it is recommended that the problem device be replaced with a known good device. Verify whether or not the problem is corrected. If not, go to Step 5 below. If the problem is corrected, the Magnum 6KM Switch and its associated cables are functioning properly.
5. If the problem continues after completing Step 4 above, contact your supplier of the Magnum 6KM Switch unit or if unknown, contact GarrettCom, Inc. by fax, phone or email (support@garrettcom.com) for assistance.

6.2 When Calling for Assistance

Please be prepared to provide the following information.

1. A complete description of the problem, including the following points:
 - a. The nature and duration of the problem;
 - b. Situations when the problem occurs;
 - c. The components involved in the problem;
 - d. Any particular application that, when used, appears to create the problem;

2. An accurate list of GarrettCom product model(s) involved, with serial number(s). Include the date(s) that you purchased the products from your supplier.
3. It is useful to include other network equipment models and related hardware, including personal computers, workstations, terminals and printers; plus, the various network media types being used.
4. A record of changes that have been made to your network configuration prior to the occurrence of the problem. Any changes to system administration procedures should all be noted in this record.

6.3 Return Material Authorization (RMA) Procedure

All returns for repair must be accompanied by a Return Material Authorization (RMA) number. To obtain an RMA number, please use this URL - https://rma.garrettcom.com/rma/rma_request_noaccount.php to fill out the form. Please have the following information readily available:

- Name and phone number of your contact person.
- Name of your company / institution
- Your shipping address
- Product name
- Serial Number (or Invoice Number)
- Packing List Number (or Sales Order Number)
- Date of installation
- Failure symptoms, including a full description of the problem.

GarrettCom will carefully test and evaluate all returned products, will repair products that are under warranty at no charge, and will return the warranty-repaired units to the sender with shipping charges prepaid (see Warranty Information, Appendix A, for complete details). However, if the problem or condition causing the return cannot be duplicated by GarrettCom, the unit will be returned as:

No Problem Found.

GarrettCom reserves the right to charge for the testing of non-defective units under warranty. Testing and repair of product that is not under warranty will result in a customer (user) charge.

6.4 Shipping and Packaging Information

Should you need to ship the unit back to GarrettCom, please follow these instructions:

1. Package the unit carefully. It is recommended that you use the original container if available. Units should be wrapped in a "bubble-wrap" plastic sheet or bag for shipping protection. (You may retain all connectors and this Installation Guide.)

CAUTION: Do not pack the unit in Styrofoam "popcorn" type packing material. This material may cause electro-static shock damage to the unit.

2. Clearly mark the Return Material Authorization (RMA) number on the outside of the shipping container.
3. GarrettCom is not responsible for your return shipping charges.
4. Ship the package to:

**GarrettCom, Inc.
47823 Westinghouse Dr.
Fremont, CA 94539
Attn.: Customer Service**

APPENDIX A: WARRANTY INFORMATION

GarrettCom, Inc. warrants its products to be free from defects in materials and workmanship for a period of three (3) years from the date of shipment by GarrettCom.

During this warranty period, GarrettCom will repair or, at its option, replace components in the products that prove to be defective at no charge other than shipping and handling, provided that the product is returned pre-paid to GarrettCom.

This warranty will not be effective if, in the opinion of GarrettCom, the product has been damaged by misuse, misapplication, or as a result of service or modification other than by GarrettCom.

GarrettCom reserves the right to make a charge for handling and inspecting any product returned for warranty repair which turns out not to be faulty.

APPENDIX B: DC Single Source Power Input

(Power Input installation to be performed by a certified electrician)

B1.0 Specifications for Magnum 6KM Switches, DC Power at 12, 24, -48, 110, 125 and 250VDC Power input

Each Magnum Model 6KM Managed Switch requires DC power input, at 12, 24, 48, 110, 125 and 250VDC nominal. The wide range of DC power input types qualifies this product for use in 12, 24, 48, 110, 125 and 250VDC applications in different industries.

DC Power Terminals: “+”, “-” are internally floating so that user may ground either

GND: ground wire connection to the 6KM chassis (#6-32 thread)



Fig B1.0a Location of chassis ground

Power Consumption:

- 15 watts typical (for a fully loaded fiber model with 2Gb)
- 10 watts typical (for 8 ports, copper and 100Mb fiber)

- 12VDC Power Input nominal (range 10 to 15VDC)
- 24VDC Power Input nominal (range 18 to 36VDC)
- 48VDC Power Input nominal (range 36 to 60VDC)
- 110VDC Power Input nominal (range 77 to 137VDC)
- 125VDC Power Input nominal (range 88 to 150VDC)
- 250VDC Power Input nominal (range 160 to 300VDC)

B2.0 12, 24, -48, 110, 125 and 250VDC POWER, THEORY OF OPERATION

The 12, 24, -48VDC, 110, 125 and 250VDC power options are designed using diodes inside on each DC power input line behind the two external power connection terminals, so that the power from an external source can only

flow into the hub. This allows the Switch to operate only whenever DC power is correctly applied to the two inputs. It protects the Switch from incorrect DC input connections. An incorrect polarity connection, for example, will neither affect the Switch, its internal power supply, nor will it blow the fuse in the internal power supply.

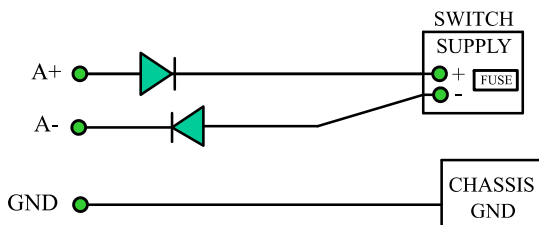
**B3.0 6KM DC SINGLE SOURCE INSTALLATION**

This section describes the proper connection of the 12, 24, -48, 110, 125 and 250VDC to the DC power connector on the Magnum 6KM Switch. The DC input connector on the Magnum 6KM Mobile Switch is located on the left front of the unit. The power terminals are connected as shown below, and they are electrically floating inside the unit so that either may be grounded by the user if desired. The chassis is “earth” or ground (GND).

The mating connection to the 6KM switch is made utilizing a RD24, locking, female connector. Simply align the keyed female connector to the 6KM male connector and twist the threaded lock to secure.

Recommended external power input connector (not supplied with 6KM):

Manufacturer: Binder-USA

Manufacturer pn: 99-4222-00-04

Safety rating: UL Recognized

Standard 6KM male DC Power Input connector:

Pin 1= A+

Pin 2= NC (Not connected)

Pin 3= NC (Not connected)

Pin 4= A-

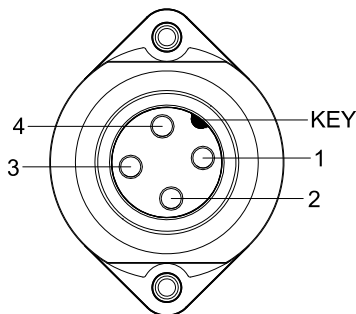

Note: for Dual-Source power input pins specification, see Section C5.0

NOTE: *The GND should be hooked up first. The 6KM unit has a floating ground, so the user may elect to Ground either + or - terminal to suit the customer's use.*

Before connecting live power lines to the input connector of -48VDC, 12VDC, 24VDC, 110VDC, 125VDC or 250VDC products, always use a digital voltmeter to measure the output voltage of the power supply and determine the lead which is more "+ve potential". The more "+ve" voltage lead from 48V or -48V supply must be connected to the post labeled "+".

After confirmation of the output voltage:

- 1. Turn off power to the supply line.*
- 2. Connect supply line to the unit.*
- 3. Apply power to the supply line.*
- 4. Confirm that the PWR led is illuminated.*

B4.0 UL Requirements for DC-powered units

CAUTION: 48VDC products shall be installed with a readily accessible disconnect device in the building installation supply circuit to the product.

Minimum 18AWG cable for connection to a Centralized DC power source.

- 1. Minimum 14AWG cable for connection to an earth wiring.*
- 2. Use only with Listed 10A circuit breaker provided in building installation.*
- 3. "Complies with FDA radiation performance standards, 21 CFR subchapter J." or equivalent.*
- 4. To secure a centralized DC Power Source cable, use at least four cable ties to secure the cable to the rack at least 4 inches apart, with the first one located within 6 inches of the input connector.*

B5.0 TROUBLESHOOTING

Please refer to Section 6.0 for troubleshooting

APPENDIX C: DC Dual Source Power Input

(Power Input installation to be performed by a certified electrician)

**C1.0 SPECIFICATIONS, DUAL SOURCE DC POWER INPUT –
FOR MAGNUM 6KM MOBILE ETHERNET SWITCHES****Power Supply (Internal, 12VDC Dual-Source, model # Dual-Src-12V)**

DC Power Connector: First Source: “A+”, “A-“, 2nd Source “B-“, “B+”

GND: ground wire connection to the hub chassis screw

Input: Two separate sources, each at 10-15 VDC

Power Supply (Internal, 24VDC Dual-Source, model # Dual-Src-24V)

DC Power Connector: First Source: “A+”, “A-“, 2nd Source “B-“, “B+”

GND: ground wire connection to the hub chassis screw

Input: Two separate sources, each at 18 - 36 VDC

Power Supply (Internal, -48VDC Dual-Source, model # Dual-Src-48V)

DC Power Connector: First Source: “A+”, “A-“, 2nd Source “B-“, “B+”

GND: ground wire connection to the hub chassis screw

Input: Two separate sources, each at 36 - 60 VDC

Power Supply (Internal, 110VDC Dual-Source, model # Dual-Src-110V)

DC Power Connector: First Source: “A+”, “A-“, 2nd Source “B-“, “B+”

GND: ground wire connection to the hub chassis screw

Input: Two separate sources, each at 77 - 137 VDC

Power Supply (Internal, 125VDC Dual-Source, model # Dual-Src-125V)

DC Power Connector: First Source: “A+”, “A-“, 2nd Source “B-“, “B+”

GND: ground wire connection to the hub chassis screw

Input: Two separate sources, each at 88 - 150 VDC

Power Supply (Internal, 250VDC Dual-Source, model # Dual-Src-250V)

DC Power Connector: First Source: “A+”, “A-“, 2nd Source “B-“, “B+”

GND: ground wire connection to the hub chassis screw

Input: Two separate sources, each at 160 - 300 VDC

With the exception of the dual DC input power connections and the power supply, all specifications and configuration options for the Magnum 6KM DC models with this Dual-Source option are identical to those listed in the *Magnum 6KM Mobile Ethernet Switches Installation and User Guide*, including Appendix B “DC Single Source Power Input”.

C2.0 MAGNUM 6KM, with DC Dual-Source option

The 6KM Switch models with the internal -48VDC, 12VDC, 24VDC, 110VDC, 125VDC and 250VDC Dual-Source power supply are designed for installations where a battery plant is the power source, and where two separate power sources are utilized in order to increase operational uptime and to simplify maintenance.

C3.0 DUAL-SOURCE OPTION, THEORY OF OPERATION

The Dual-Source DC power option is designed using diodes inside of the chassis on each DC power input line. A diode is placed in each of the four input lines (behind the four external power connection terminals) so that power from an external source can only flow into the unit. This allows the unit to operate whenever DC power is correctly applied to either or both of the two inputs.

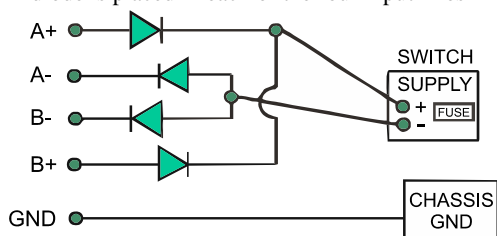

C4.0 FEATURES AND BENEFITS OF THE DUAL-SOURCE DESIGN

- The Switch unit can receive power from either input, “A” or “B”. The hub will normally draw its power from the DC source with the highest voltage at a given time.
- The Switch unit will not allow power to flow from a higher voltage input to a lower voltage input, i.e. the two DC power sources are not mixed together by the hub.
- When one correct DC input is present, the Switch will receive power if the other DC input is absent, or even if it is connected with reverse polarity or shorted or grounded.
- Reverse polarity connections, if they should accidentally occur on either input, will not damage the Switch or power supply internally (nor will it blow the fuse in the internal power supply) because of the blocking action of the diodes. This is true even if one input connection is reversed while the Switch is operating from the other source.
- The Switch will not receive power (and will not work) when both inputs are simultaneously absent or are both incorrectly connected.

C5.0 6KM DUAL SOURCE INSTALLATION

This section describes the proper connection of the 12, 24, -48, 110, 125 and 250VDC dual source leads to the power input connector on the Magnum 6KM Switch.

The DC input connector on the Magnum 6KM Mobile Ethernet Switch is located on the left front of the unit. The power terminals are connected as shown below, and they are electrically floating inside the unit so that either may be grounded by the user if desired. The chassis is “earth” or ground (GND).

The mating power cable connection to the 6KM switch is made utilizing a RD24, locking, female connector. Simply align the keyed female connector to the 6KM male connector and twist the threaded lock to secure.

Recommended external power input connector (not supplied with 6KM):

Manufacturer: Binder-USA

Manufacturer pn: 99-4222-00-04

Safety rating: UL Recognized

Standard 6KM (Dual Source) male DC Power Input connector:

Pin 1= A+

Pin 2= B+

Pin 3= B-

Pin 4= A-

A= Primary circuit

B= Secondary circuit

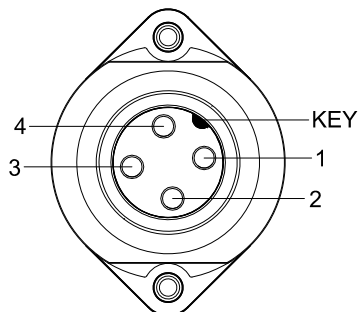

NOTE: The GND should be hooked up first. The 6KM unit has a floating ground, so the user may elect to Ground either + or - terminal to suit the customer's use.

Before connecting live power lines to the input connector of -48VDC, 12VDC, 24VDC, 110VDC, 125VDC or 250VDC products, always use a digital voltmeter to measure the output voltage of the power supply and determine the lead which is more "+ve potential". The more "+ve" voltage lead from 48V or -48V supply must be connected to the post labeled "+".

After confirmation of the output voltage:

1. Turn off power to the supply line.
2. Connect supply line to the unit.
3. Apply power to the supply line.
4. Confirm that the PWR led is illuminated.

C6.0 ORDERING INFORMATION FOR DUAL SOURCE DC POWER

To order the optional Dual-Source DC power supply factory installed, add "Dual-Src-xxx" as a separate line item following the product model.

Example: **Magnum 6KM-48VDC**

Dual-Src-48V

APPENDIX D: AC Power Input**D1.0 Specifications for Magnum 6KM-AC Switches, AC Power input**

The AC power input connector on the Magnum 6KM Mobile Switch is located on the left front of the unit. The power terminals are connected as shown below. The chassis is “earth” or ground (GND).

Each Magnum Model 6KM-AC Managed Switch requires AC power input, at 100-240VAC Power Input, 47 to 63 Hz (auto-ranging).

The mating power cable connection to the 6KM switch is made utilizing a RD24, locking, female connector. Simply align the keyed female AC power cable connector to the 6KM male AC power input connector and twist the threaded lock to secure.

Recommended external power input connector (not supplied with 6KM):

Manufacturer: Binder-USA

Manufacturer pn: 99-4222-00-04

Safety rating: UL Recognized

Standard 6KM male AC Power Input connector:

- Pin 1= +
Pin 2= -
Pin 3= NC (Not connected)
Pin 4= GND

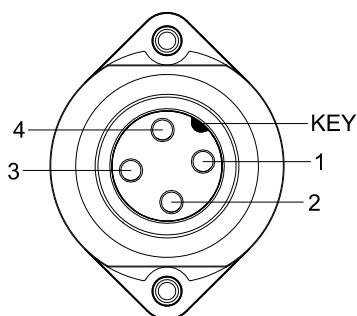

After confirmation of 6KM-AC model is installed:

- 1. Connect AC supply line to the unit.**
- 2. Apply power to the supply line.**
- 3. Confirm that the PWR led is illuminated.**