

Magnum 3000X Stackable Concentrators

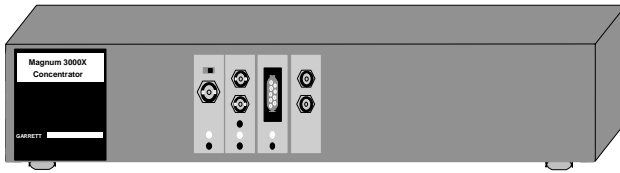

Installation and User Guide

Magnum™ 3000X

Stackable Concentrators

Installation and User Guide

Part #: 84-00018 (R 05/02)

Trademarks

UL is a registered trademark of Underwriters Laboratories

Ethernet is a trademark of Xerox Corporation

UL is a registered trademark of Underwriters Laboratories

Magnum is a trademark and **Personal Hub** is a registered trademark of GarrettCom, Inc.

Important: The Magnum 3000X Stackable Concentrators contains no user serviceable parts. Attempted service by unauthorized personnel shall render all warranties null and void. If problems are experienced with Magnum 3000X Stackable Concentrators, consult Section 5, Troubleshooting, of this User Guide.

Copyright © 2002 GarrettCom, Inc. All rights reserved. No part of this publication may be reproduced without prior written permission from GarrettCom, Inc.

Printed in the United States of America.

Contacting GarrettCom, Inc.

Please use the mailing address, phone and fax numbers and email address listed below:

GarrettCom, Inc.
47823 Westinghouse Dr.
Fremont, CA 94539
Phone: 510.438.9071
Fax: 510.438.9072
Web: <http://www.garrettcom.com>
Email support@garrettcom.com

Federal Communications Commission Radio Frequency Interference Statement

This equipment generates, uses and can radiate frequency energy and if not installed and used properly, that is in strict accordance with the manufacturer's instructions, may cause interference to radio communication. It has been tested and found to comply with the limits for a Class A computing device in accordance with the specifications in Subpart J of Part 15 of FCC rules, which are designed to provide reasonable protection against such interference when operated in a commercial environment. Operation of this equipment in a residential area is likely to cause interference, in which case the user at his/her own expense will be required to take whatever measures may be required to correct the interference.

Table of Contents	
1.0 Technical Specifications, 3000X Base Unit	1
1.1 Specs - Repeater Port Modules; 3000X and Bonus Ports	3
1.2 Specs - Bridge Port Modules; 3000X and Bonus Ports	3
1.3 Ordering Information	4
2.0 Introduction - Magnum 3000X Mixed-Media Concentrator	5
2.1 Inspecting the Package and Product.....	5
2.2 Product Description - Magnum 3000X Stackable Concentrators	6
2.2.1 The Magnum 3000X Stackable Concentrator Chassis	6
2.3 Repeater Port Modules	8
2.4 Bridge Port Modules	9
2.5 SNMP Agent - Optional.....	10
2.6 Features and Benefits	10
2.7 Applications	11
2.8 Magnum 3000X Installation.....	12
2.8.1 Locating the Magnum 3000X	13
2.8.2 Connecting Ethernet Media.....	13
2.8.3 Connecting Twisted Pair	13
2.8.4 Connecting ThickNet 10BASE5	14
2.8.5 Connecting ThinNet 10BASE2	15
2.8.6 Connecting Drop Cable 10BASE5	15
2.8.7 Connecting Fiber Optic 10BASE-FL and FOIRL.....	16
2.8.8 Connecting Fiber Optic	16
2.8.9 Connecting Single-Mode Fiber Optic	17
2.8.10 Power Budget Calcs for Magnum 3000X PM's w/Fiber Media	17
2.8.11 Rack-mounting.....	18
2.8.12 Inter-Repeater Bus Connections.....	19
2.8.13 Segmenting a Magnum 3000 Stack with a Special Cable.....	20
2.8.14 SNMP Agent's Connections	21
2.9 Port Module Installation.....	21
2.9.1 Preparation for Installing and Removing PMs	22
2.10 Installing PM Cards in the Magnum 3000X	23
2.11 Removing PM Cards	24
2.12 Operation.....	25
2.12.1 Repeater Functionality	25
2.12.2 BPM Local Bridge Functionality	26
2.13 Powering the Magnum 3000X	29
2.14 Chassis LEDs	29
3.0 Introduction - Magnum Port Modules	30
3.1 Inspecting the Package and Product.....	30
3.2 Product Description.....	30
3.2.1 RPM-BNC.....	31
3.2.2 RPM-AUI.....	32
3.2.3 RPM-DTE	34
3.2.4 RPM-FST	34

3.2.5	RPM-FSC	35
3.2.6	RPM-SMF	35
3.2.7	RPM-TP	36
3.2.8	PM-FP.....	37
3.2.9	BPM-BNC	38
3.2.10	BPM-AUI	38
3.2.11	BPM-FST.....	38
3.2.12	BPM-TP.....	39
4.0	Intro - Simple Network Management Protocol Agents.....	40
4.1	SNMP Agents Description	40
4.1.1	Embedded SNMP Agent, Model 3000-MB.....	40
4.1.2	Separate Agent Box, Model 3000-AGT	41
4.1.3	Standard Repeater MIB and Extensions	42
4.2	Installation, General Information.....	44
4.3	Installing the Embedded Agent Board, "MB"	44
4.4	Agent Configuration, Embedded Agent and Agent Box Versions....	48
4.4.1	Automatic Agent IP Address Configuration.....	48
4.4.2	Manual IP Address Configuration.....	49
4.4.3	Other Convenience Commands	51
5.0	TROUBLESHOOTING	52
5.1	Before Calling for Assistance	52
5.2	When Calling for Assistance	53
5.3	Return Material Authorization Procedure.....	53
5.4	Shipping and Packaging Information	54
APPENDIX A: WARRANTY INFORMATION.....		55
APPENDIX B : Internal DC Power Supply Option.....		55
APPENDIX C : Internal DC Dual-Source Power Option		58
R05/02: Updated Rack-mounting and Appendix B & C with 24VDC and 125VDC Power Supply Option		
R01/02: UPDATED OPERATING ENVIRONMENT SPECIFICATIONS		
R03/01: CHANGE THE COMPANY’S NAME TO GARRETTCOM, INC.(FORMERLY IT WAS GARRETTCOM, INC.). THERE ARE NO CHANGES MADE TO THE CONTENT MATERIAL AT THIS TIME.		
R03/99: THIS REVISION REVISES THE APPENDICES COVERING -48V POWER OPTIONS.		
R10/98: THIS REVISION SEPARATES THE MAGNUM 3000X HUBS MANUAL FROM THE 3000S HUB MANUAL, AND REVISES THE APPENDICES COVERING -48V POWER OPTIONS.		
R09/97: THIS REVISION INCLUDES A SAFETY PRECAUTION AT THE BEGINNING OF BOTH INSTALLATION SECTIONS FOR THE 3000X AND THE RPM-FSC		
R03/97: THIS REVISION INCLUDES A NEW APPENDIX A: THE 48VDC POWER OPTION, THE PREVIOUS APPENDIX A: WARRANTY INFORMATION IS NOW LABELED AS APPENDIX B.		
R01/96: MAGNUM 3000S HUB FAMILY, AND MAGNUM 3000X CONCENTRATOR		

THE MAGNUM LINE

Ethernet connectivity products

"Designed and Manufactured in the USA"

Overview

GARRETTCOM, INC. OFFERS THE PREMIUM-QUALITY MAGNUM™ LINE OF ETHERNET LAN CONNECTIVITY PRODUCTS WITH INDUSTRY-STANDARD FUNCTIONALITY AND BUILT-IN FIBER CONFIGURABILITY. MAGNUM PRODUCTS ARE DESIGNED FOR USE IN DEMANDING CARRIER CLASS, INDUSTRIAL GRADE AND OEM APPLICATIONS WHERE RELIABILITY IS A PRIMARY CONSIDERATION.

6K25 MANAGED FIBER SWITCHES, GIGABIT, 100 & 10MBPS, FIBER AND COPPER PORTS, MIX-AND MATCH. FEATURES SFF FIBER FOR UP TO 25 FIBER PORTS IN A 1U UNIT.

4K-SERIES SWITCHES, 100 & 10MBPS, COPPER PORTS WITH OPTIONAL FIBER PORT, WITH AUTO-NEGOTIATING FULL SWITCHING PERFORMANCE.

QUAD-SERIES FIBER SWITCHES, 100 & 10MBPS, FIBER AND COPPER PORTS, MIXED-SPEED AND MIXED-MEDIA TYPES, FULL SWITCHING PERFORMANCE.

“OUTDOOR” ETHERNET SWITCH, FOR TEMPERATURE UNCONTROLLED LOCATIONS

6 10/100 AND 2 100MB FIBER PORTS, CAN BE CONNECTED IN STRINGS

MIXED-MEDIA FIBER HUB, 16-PORT STACKABLE, 10/100 AUTO-SENSING

DUAL SPEED 8-PORT AND 16-PORT STACKABLES, 10/100 AUTO-SENSING

STACKABLE HUBS, SNMP OPTIONAL

10MB SERIES AND 100MB SERIES, BOTH W/ OPTIONAL PORT MODULES

PERSONAL SWITCHES, 10/100MB

8 PORT DUAL SPEED, AUTO-NEGOTIABLE WITH FIBER OPTION

PERSONAL HUBS, 100MB OR 10/100MB

8-PORT, WITH TWO SWITCHED PORTS (1 FIBER BUILT IN)

PERSONAL HUBS, 10MB SERIES

8-PORT + AUI, STACKABLE TO 5 HIGH, + OPTIONAL BNC OF FIBER PORT
8 OR 9-PORT AND 4 OR 5-PORT PERSONAL HUBS, W/ MAN. UP-LINK SW.

MEDIA CONVERTERS, 10MB AND 100MB SERIES

ALL MEDIA COMBINATIONS, INCL. FIBER ST, SC, MM., SINGLE MODE

THE “X-LINE” OF CONFIGURABLE MIXED MEDIA PRODUCTS:
STACKABLE CONCENTRATORS, SNMP OPTIONAL, 13-PORTS
MINI-CONCENTRATORS, 7 PORTS, REPEATERS, 2-PORTS
REPEATER PORT MODULES (RPMS), 6 TYPES FOR ETHERNET MEDIA
BRIDGE PORT MODULES (BPMS), 4 TYPES, FOR SEGMENT ISOLATION
TRANSCEIVERS, 10MB SERIES MINI-TRANSCEIVERS AND COAX
MODELS MAY,

1.0 Technical Specifications, 3000X Base Unit

Performance

Data Rate:	10 Mbps
RPM Partitioning:	Enforced after 32 consecutive collisions
RPM Reconnect:	Occurs after 512 bits error-free reception
BPM Auto-Learning Address List:	256 nodes capacity
BPM Filtering and Forwarding Rate:	14,880 pps max.

Maximum Ethernet Segment Lengths

DTE (AUI Drop Cable)	- 50 m (164 ft)
10BASE-T (twisted pair)	- 100 m (328 ft)
Shielded twisted pair	- 150m (492 ft)
10BASE2 ThinNet (BNC)	- 185 m (607 ft)
10BASE5 ThickNet	- 500 m (1,640 ft)
FOIRL multi-mode Fiber optic	- 1 km (3,281 ft)
10BASE-FL multi-mode Fiber optic	- 2 km (6,562 ft)
Single-mode Fiber optic	- 10 km (32,810 ft)

Network Standards

Ethernet V1.0/2.0 IEEE 802.3: 10BASE-T, 10BASE5,
10BASE2, 10BASE-FL & FOIRL, and DTE

Operating Environment

Ambient Temperature:	32°F to 113°F (0°C to 45°C)
Storage Temperature:	-20°C to 60°C
Ambient Relative Humidity:	10% to 95% (non-condensing)

Port Connector Types

RJ-45:	Shielded, 8-Pin Female (Note: <i>Shielded 10BASE-T connectors accept either unshielded or shielded wiring plugs for standard twisted pair media wiring.</i>)
Fiber Optic:	ST (Twist-Lock Connector, for single and multi-mode)
Fiber Optic:	SMA (Screw-on Connector, for multi-mode, special order only)
ThinNet:	BNC
AUI:	D-Sub 15-Pin Female (with slide lock)
DTE:	D-Sub 15-Pin Male (with lock posts)

Power Supply (Internal)

AC Power Connector:	IEC-type, male recessed, rear of chassis
Input Voltage:	100 - 240 vac (auto-ranging)
Input Frequency:	47 - 63 Hz (auto-ranging)
Power Consumption:	Model 3000X : 65 watts max

DC Power Supply (Options)

-48VDC Power Input Voltage: 36 to 72 VDC

24VDC Power Input Voltage: 20 to 36VDC

125VDC Power Input Voltage: 120 to 160VDC

Std. Terminal Block: “ -, GND, + ”

Power Consumption: same as for AC models, see above

For Dual Source and Redundant DC for -48VDC, 24VDC Power & 125VDC supply options (Optional), see Appendices.

Packaging

Enclosures: High strength sheet metal, suitable for wiring closet shelf, rack or tabletop mounting.

Dimensions: 9 cm x 43.2 cm x 8.9 cm)

Weight: 5.2 lbs (2.4 Kg)

Cooling method: Fan cooled, internal @ 15cfm

LED Indicators on Chassis Front

PWR - Power, Green LED, steady on when AC power is applied.

LINK - Steady On when twisted pair link is operational, flashing if the port is partitioned by hardware

RX - Receive, Green LED, blinks indicating network activity, data being received from any of the PMs.

COL - Collision, Yellow LED, illuminates when a collision is detected on any of the PM ports.

JAB - Jabber, Amber LED, illuminates when jabber condition (illegal packet length) is detected on any port; affected port is partitioned temporarily until jabber stops.

Agency Approvals

UL Listed (UL 1950), cUL, CE

Emissions: meets FCC Part 15 Class A

Warranty

Three years, return to factory

Made in USA

1.1 Specifications - Repeater Port Modules (RPMs); 3000X and Bonus Ports

RPM Type:	BNC	AUI	DTE	Fiber-mm	Fiber-sgl.m	TP*
Front Access	yes	yes	yes	yes	yes	yes
Connector Type	BNC-f	DB-15 f	DB-15 m	Fiber-ST	Fiber-ST	RJ-45
Partition (PART) LED	yes	yes	yes	yes	yes	yes
Receive (RX) LED	yes	yes	yes	yes	yes	yes
LINK LED	n.a.	n.a.	n.a.	yes	yes	yes
Switch on Face Plate	yes**	n.a.	n.a.	n.a.	n.a.	yes***

"Fiber-mm" is multi-mode cable, normally used for 10BASE-FL installations, up to 2.0Km.

"Fiber-sgl.m" is single-mode cable, used for distant installations, up to 10.0Km.

* The RJ-45 connector is shielded; it accepts RJ-45 eight-pin plugs for unshielded and shielded twisted pair wiring.

** Internal termination switch for BNC, no "T" connector is required.

*** MDI-X (Media Dependent Interface - Crossover) switch for RJ-45 uplink, no crossover cable is required.

1.2 Specifications - Bridge Port Modules (BPMs); 3000X and Bonus Ports

BPM Type:	BNC	AUI	Fiber	TP*
Connector Type	BNC (f)	DB-15 (f)	ST	RJ-45
Switch on FP	yes**	n.a.	n.a.	yes***
FWD-I LED	yes	yes	yes	yes
FWD-X LED	yes	yes	yes	yes
LINK LED	n.a.	n.a.	yes	yes

* The RJ-45 connector is shielded; it accepts RJ-45 eight-pin plugs for unshielded and shielded twisted pair wiring.

** Internal termination switch for BNC, no "T" connector is required.

*** MDI-X (Media Dependent Interface - Crossover) switch for RJ-45 uplink, no crossover cable is required.

1.3 Ordering Information

Magnum 3000 Stackable Hubs and Concentrators

Magnum 3000X	Base Chassis with 13 (12 front, one rear) PM slots
Magnum 3000X-PM**	Designates a PM** to be installed in the rear bonus slot

Network Management Options:

Magnum 3000-MB	SNMP option, Embedded Agent Board
Magnum 3000-AGT	SNMP option, Embedded Agent Box as a separate stack unit
Magnum 3000-NMS	"SNMP" PC / Windows-based Network Management Software product from Castle Rock Computing.

Port Modules (PMs):

Magnum RPM-BNC	Module with 1 BNC connector, internal termination switch
Magnum RPM-TP	Module w/ 1 shielded female RJ-45 connector + up-link switch
Magnum RPM-AUI	Module with 1 AUI (DB-15 female) connector, with slide lock
Magnum RPM-DTE	Module with 1 DTE (DB-15 male) connector, with lock posts
Magnum RPM-FST	Module w/ mm* Fiber ST "twist" 10BASE-FL dual connector
Magnum RPM-FSC	Module w/ mm* Fiber SC "snap" 10BASE-FL dual connector
Magnum RPM-SMF	Module w/ single-mode Fiber connector

Magnum BPM-BNC	Local Bridge Module with 1 BNC connector
Magnum BPM-AUI	Local Bridge Module with 1 AUI connector
Magnum BPM-FST	Local Bridge Module with mm* Fiber ST connector
Magnum BPM-TP	Local Bridge Module with 1 RJ-45 connector + uplink switch

Magnum PM-FP	Face Plate - cover for unused front slots
--------------	---

* mm = multi-mode.

** These items must be included to convey configuration information to the factory. For example, to order a Model 3000X Hub with a BNC type RPM option factory installed in the rear bonus port slot, you must include Model "3000X-PM" and Model RPM-BNC as separate line items, in order to specify that the RPM-BNC is to be factory-configured in the bonus port.

***Available by special order only.

GarrettCom reserves the right to change specifications, performance characteristics and/or model offerings without notice.

2.0 Introduction - Magnum 3000X Mixed-Media Concentrator

This chapter describes the features and capabilities of the Magnum 3000X Concentrator, including Port Modules (PMs), applications, installation, and operation.

2.1 Inspecting the Package and Product

Examine the shipping container for obvious damage prior to installing this product; notify the carrier of any damage, which you believe occurred during shipment or delivery. Inspect the contents of this package for any signs of damage and ensure that the items listed below are included.

This package should contain:

- 1 - Magnum 3000X Base Unit
- 1 - AC Power Cord (U.S. and other 115 vac only)
- 1 - Set of metal "Ears" for optional rack mounting
- 1 - Inter-Repeater Bus (IRB) ribbon cable with connectors
- 1 - Installation and User Guide
- 1 - Product Registration Card

Note: Port Modules (PMs) purchased with the 3000X unit are usually factory configured and installed, and may be included as part of the 3000X unit.

Remove the unit from the shipping container. Be sure to keep the shipping container should the unit need to be shipped at a later date. To validate the product warranty, please complete and return the enclosed Product Registration Card to GarrettCom, Inc. as soon as possible.

In the event there are items missing or damaged contact the supplier. If the unit needs to be returned please use the original shipping container. Refer to Chapter 6, Troubleshooting, for specific return procedures.

2.2 Product Description - Magnum 3000X Stackable Concentrators

The Magnum 3000X is a highly versatile, cost effective mixed media Ethernet Concentrator that provides up to thirteen ports for Ethernet connectivity. Twelve port slots are located on the front of the unit and the thirteenth slot, offered as a bonus slot, is located on the rear of the unit.

Combinations of standard Ethernet media types are supported. These include 10BASE-FL, FOIRL, 10BASE2, 10BASE5, and 10BASE-T. The Magnum 3000X also supports an optional SNMP agent for management that can either be included upon initial purchase or added later. (For more detailed information about network management and SNMP agents, see Chapter 4.)

The Magnum 3000X is designed with the capability to be stacked with other Magnum 3000Xs and/or with Magnum 3012s and Magnum 3024s. Magnum 3000X units may be configured in a stack with as many as 20 total units. In a stacked configuration, the complete stack operates as a single logical repeater. Depending upon the stack configuration (any mix of Magnum 3000Xs, Magnum 3012s and/or Magnum 3024 units), up to 500 Ethernet segments may be supported.

The Magnum 3000X is compact in design at only 3.5 in. (8.9 cm) high, and has a lightweight metal enclosure. It is easily rack mounted in a standard 19" rack and typically operates as the central hub for a multiple-backbone Ethernet network.

2.2.1 The Magnum 3000X Stackable Concentrator Chassis

The Magnum 3000X chassis functions as a 13-slot unit that provides full repeater functionality. Each slot supports a single Repeater Port Module (RPM) to provide 10BASE-FL, FOIRL, 10BASE2, 10BASE5, or 10BASE-T Ethernet connectivity. The individual RPMs are used for one Ethernet port connection each. In conjunction with the 3000X chassis, they provide full IEEE 802.3 repeater functionality.

Figure 2.2.1a: Magnum 3000X, Front View

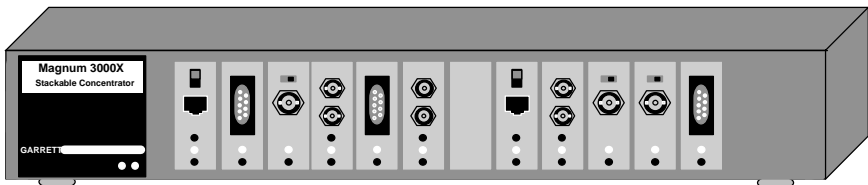

Each PM is equipped with a single media interface connector. Any RPM can be installed in any slot of the Magnum 3000X chassis. BPMs, normally configured as a maximum of one per 3000X stack, are physically larger than RPMs internally, and can be installed only in the rear bonus port slot or the right-most four front slots (to avoid conflict in cases where an SNMP agent board is mounted inside).

When configured with multiple RPMs for single or mixed media applications, the total combination of RPMs will operate as a single repeater. When configured with a BPM, the 3000X's nodes along with the nodes on the other units in the stack are bridge-isolated from the up-stream network segment connected to the BPM port.

The front of the Magnum 3000X chassis features LEDs for Power (PWR), Receive (RX), Collision (COL), and Jabber (JAB). These LEDs provide a visual assessment of the operational condition and aggregate network activity of all segments installed in the unit.

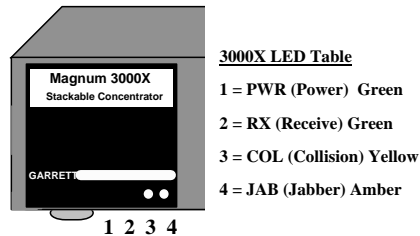

Figure 2.2.1b: Front Panel LEDs

The back of the Magnum 3000X is illustrated in Figure 3.2.1c, below.

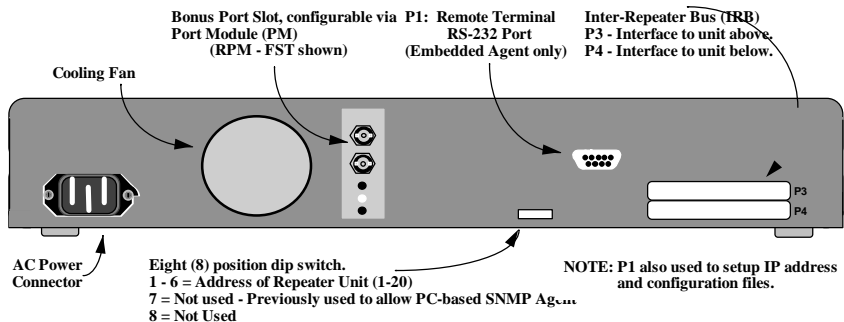

Figure 2.2.1c: Magnum 3000X Rear Panel View

AC Power Connector: On the left side of the unit is the connection to the auto-ranging internal power supply that automatically adapts to the AC voltage of the AC power system into which it is being installed. AC Power input may be from 100 to

240 vacs with a frequency of 47 to 63 Hz. (When shipped for use outside the U.S. and Canada, a 115-vac power cord is not included.)

Cooling Fan: The Magnum 3000X is equipped with a low noise 15 cfm fans. The fan will maintain low temperature operation inside the unit to maximize reliability.

Bonus PM Slot: The Magnum 3000X features a 13th slot that is rear-mounted and is optionally configured with any one of the port module (PM) types.

8 Position Switch: The 8-position switch is used to configure a Group # address for each unit in a managed stack. This allows an SNMP agent (if optionally present) to identify and report each unit in the stack to the network management software. Information covering the SNMP Agents is provided in Chapter 5. Instructions for configuring the Group # address switches on the Magnum 3000X are the same as for the Magnum 3024 Hub, discussed in Section 2.3.2.

Port 1 DB-9 Connector: Port 1, or "P1", is optional and is used with the embedded SNMP agent daughter board. P1 is only present when the embedded SNMP agent daughter board is installed; otherwise this location is covered with a blank faceplate. Instructions for P1 on the Magnum 3000X are the same as for the Magnum 3024 Hub, and are discussed in Section 2.3.2.

“P2” NOTE: 3000X units shipped before February, 1995, have a “P2” rear connector, used for an optional PC-based external software SNMP Agent. This option is discontinued, and there is no “P2” on current 3000X models.

Inter-Repeater Bus (IRB): The IRB allows any units within the Magnum 3000 family to be interconnected to form one logical repeater. Instructions for the IRB on the Magnum 3000X are discussed in detail in "Stacking Magnum 3000s", Section 2.8.10, and in "Segmenting a Magnum 3000 Stack with a Special Segmenting Cable", Section 2.8.11

2.3 Repeater Port Modules (RPMs)

To provide maximum application flexibility, individual Repeater Port Modules (RPMs) are used with the Magnum 3000X. The Magnum 3000X features 12 PM slots on the front of the unit and a bonus slot on the rear of the unit, some or all of which may be configured with RPMs. The bonus slot allows for an additional rear-mounted Ethernet segment connection, typically to a backbone. With the bonus slot, the Magnum 3000X becomes a 13 port unit.

There are a total of six standard RPM cards, each with a media cable

connector. A seventh module is used as a faceplate when any front slot is not used. The standard network connector types for RPMs are BNC (ThinNet or 10BASE2), AUI

(10BASE5 or ThickNet, DB-15 female for most transceiver connections), DTE (DB-15 male-AUI for direct connects), ST (Multi-mode Fiber ST), SC (Multi-mode Fiber SC), SMF (Ethernet Single-mode Fiber), and RJ-45 (10BASE-T UTP and STP). They are shown in Figure 3.3a. RPM-SMF (not shown) looks exactly like RPM-FST.

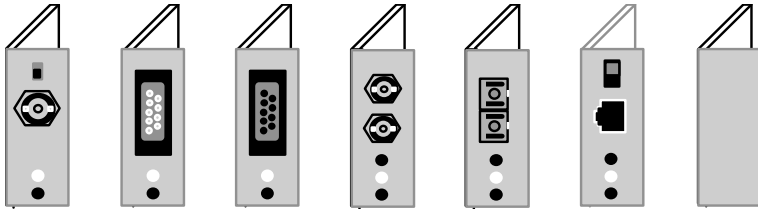

Figure 2.3a: Magnum RPM Cards: RPM-BNC, RPM-AUI, RPM-DTE, RPM-FST, RPM-FSC, RPM-TP, & PM-FP

Magnum RPMs are normally installed in Magnum 3000Xs at the factory prior to shipment, but may be installed or changed or removed in the field by a trained technician. These procedures are described in general overview form in this User Guide, Section 3.8, 3.9, and 3.10, for the 3000X. The addition of bonus port RPMs in the field may require internal ribbon cables only available as Spare Parts, and additional instructions and training.

2.4 Bridge Port Modules (BPMs)

To provide optional local segment isolation, Bridge Port Modules (BPMs) are available for the Magnum 3000X.

NOTE: *BPMs are physically larger in depth than RPMs, and are best located in the rear bonus port or the 4 right-most front ports of the 3000X. Furthermore, due to internal physical space constraints, BPMs **cannot** be located in ports 1-8 (left-most 8 front ports) of a 3000X unit housing an embedded agent. Since BPMs are normally configured one per stack (typically in the bonus port), this limitation should have little practical impact.*

There are four different BPM cards, each designed with its own media cable connector type. The standard Ethernet network connector types for BPM cards are BNC (ThinNet or 10BASE2), AUI (10BASE5 or ThickNet, DB-15 female for most transceiver connections), FST (Ethernet multi-mode Fiber ST), and TP (10BASE-T RJ-45 for shielded or unshielded twisted pair). These are shown in figure 3.4a.

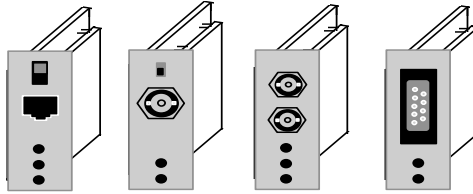

Figure 2.4a: Magnum BPM Cards: BPM-TP, BPM-BNC, BPM-FST, BPM-AUI

A Magnum BPM is normally installed in a Magnum 3000X at the factory prior to shipment, but may be installed or changed or removed in the field by a trained technician. These procedures are described in general overview form in this User Guide, Section 3.8, 3.9, and 3.10, for the 3000X. The addition of a bonus port BPM in the field may require an internal ribbon cable only available as Spare Parts, and additional instructions and training.

2.5 SNMP (Simple Network Management Protocol) Agent - Optional

An SNMP agent is not required for basic operation on the 3000X. The Magnum 3000X may optionally be configured with an SNMP Embedded Agent, Model 3000-MB, factory-mounted inside. An SNMP agent in a box, Model 3000-AGT, is also available as an option and is easily installed in the field.

See Chapter 4 for additional details on the Magnum SNMP agent options.

2.6 Features and Benefits

■ 13 Mixed-Media Ports in a Single Unit

The Magnum 3000X allows any mix of standard Ethernet media to reside in one unit, up to thirteen different segments, and therefore can be used to expand and re-configure any new or existing Ethernet network. The 3000X is also economical as a multi-port repeater; for example, 12 BNC and one AUI repeater ports per unit.

■ **Optional SNMP Agent**

A Magnum 3000X unit or stack may optionally be configured with an SNMP agent. The SNMP agent is field installable and is available as either an embedded board or a separate "agent box" stacking unit.

■ **Stackable and Scaleable Configurations**

The Magnum 3000X is equipped with an inter-repeater bus that allows multiple units (up to twenty 3000X units) to be stacked, thus supporting up to 260 RPMs with Ethernet mixed media ports operating as a single repeater. Units may easily be added to the stack for expansion of the system, providing flexible growth of networks of differing media types.

■ **Optional Bridge Port Modules**

The Magnum 3000X can be optionally configured with a BPM (one per stack). BPMs contain a miniature, self-learning local bridge module capable of filtering and forwarding packets at full Ethernet wire speed. A BPM may be used to bridge-isolate the nodes on a local stack segment having significant local traffic, thus boosting overall network performance. BPMs are available with BNC, AUI, multi-mode Fiber-ST, and RJ-45 media connectors.

■ **Internal Power Supply with Auto-ranging**

An internal universal power supply allows any Magnum 3000X unit to be used with the normal AC power types found throughout the world.

- **LEDs for Chassis and PM Cards** The Magnum 3000X chassis and each of the 12 front-mounted PM cards are equipped with traffic activity and segment-status LEDs. These LEDs are all visible from the front of the unit for convenient monitoring.

2.7 Applications

The Magnum 3000X Mixed-Media Concentrators provide connectivity and/or segment isolation between multiple and various Ethernet media types from a single chassis device and include support for the following IEEE 802.3 standards:

10BASE5, 10BASE2, 10BASE-T, 10BASE-FL, FOIRL.

Where more than one type of Ethernet media is required, the Magnum 3000X easily integrates a mixed-media network.

In addition to mixed-media support, the Magnum 3000X allows the integration of Magnum 3024 and 3012 Hubs within a single stack with optional SNMP.

The Magnum 3000X Stackable Concentrator will function properly when the network installation follows IEEE standards for the various Ethernet media. Each media type has different installation limitations based on IEEE 802.3 standards, and those specifications should be adhered to for all applications. A summary of each Ethernet media type and the corresponding Magnum PM(s) is presented here:

<u>IEEE Standard</u>	<u>Reference</u>	<u>Max. Distance</u>	<u>Taps</u>	<u>PM Type</u>
Drop Cable AUI	AUI	50m (165 ft)	n/a	RPM-AUI, RPM-DTE, BPM-AUI
10BASE5	ThickNet	500m (1640 ft)	100	RPM-AUI, BPM-AUI
10BASE2	ThinNet	185m (607 ft)	30	RPM-BNC, BPM-BNC
10BASE-T	Twisted Pair	100m (328 ft)	n/a	RPM-TP, BPM-TP
FOIRL	mm ¹ Fiber	1.0km(3281 ft)	n/a	RPM-FST, RPM-FSC, RPM-FSM, BPM-FST
10BASE-FL	mm ¹ Fiber	2.0km(6562 ft)	n/a	RPM-FST, RPM-FSC, RPM-FSM, BPM-FST
*	sgl.m ² Fiber	10.0km(65620ft)	n/a	RPM-SMF

¹ mm = multi-mode

² sgl.m = single-mode

* IEEE does not currently standardize single-mode fiber

See also Technical Specifications for additional Magnum 3000X information that may indicate suitable applications.

2.8 Magnum 3000X Installation

Before installing the equipment, it is necessary to take the following precautions:

- 1.) If the equipment is mounted in an enclosed or multiple rack assembly, the environmental temperature around the equipment must be less than or equal to 50°C.
- 2.) If the equipment is mounted in an enclosed or multiple rack assembly, adequate airflow must be maintained for proper and safe operation.
- 3.) If the equipment is mounted in an enclosed or multiple rack system placement of the equipment must not overload or load unevenly the rack system.
- 4.) If the equipment is mounted in an enclosed or multiple rack assembly, verify the equipment's power requirements to prevent overloading of the building/s electrical circuits.
- 5.) If the equipment is mounted in an enclosed or multiple rack assembly verify that the equipment has a reliable and uncompromised earthing path.

This section describes the installation of the Magnum 3000X concentrator, as well as connection of the various Ethernet media types.

2.8.1 Locating the Magnum 3000X

The location of the Magnum 3000X is dependent on the physical layout of the network and the area to be served. The unit is typically rack mounted in a wiring closet but because it has rubber feet it can also be installed on a shelf or tabletop. While stacks of 3 to perhaps 5 units and the associated cabling can be accommodated on a shelf or tabletop, it is recommended that larger stacks be rack mounted. Each unit is shipped with a pair of metal "ears" that attach to each side of the unit to easily accommodate mounting in standard 19" RETMA racks.

See Section 3.21 for AC power considerations

2.8.2 Connecting Ethernet Media

The Magnum 3000X Concentrator is specifically designed to support all Ethernet media types within a single unit. This is accomplished by using a family of Port Modules (PMs). The various media types supported along with the corresponding IEEE 802.3 standards and connector types are as follows:

<u>Media</u>	<u>IEEE Standard</u>	<u>Connector</u>	<u>PM type</u>
ThinNet	10BASE2	BNC	RPM-BNC, BPM-BNC
ThickNet	10BASE5	AUI (female)	RPM-AUI, BPM-AUI
Drop Cable	10BASE5	DTE (male)	RPM-DTE
Twisted Pair	10BASE-T	RJ-45	RPM-TP, BPM-TP
Fiber (mm ¹)	FOIRL	ST or SMA	RPM-FST, RPM-FSC, RPM-FSM, BPM-FST
Fiber (mm ¹)	10BASE-FL	ST or SMA	RPM-FST, RPM-FSC, RPM-FSM, BPM-FST
Fiber (sgl.m ²)	*	ST	RPM-SMF

¹ mm = multi-mode

² sgl.m = single-mode

* IEEE does not currently standardize single-mode fiber

2.8.3 Connecting Twisted Pair (RJ-45, Unshielded or Shielded)

The following procedure describes how to connect a 10BASE-T twisted pair segment to the RJ-45 port on the front panel of the 3000 hub or to the RPM-TP or BPM-TP of the 3000X or bonus port. The procedure is the same for both unshielded and shielded twisted pair segments.

1. Using standard 10BASE-T media, insert either end of the cable with an RJ-45 plug into the RJ-45 connector. Note that, even though the TP connector is shielded, either unshielded or shielded 10BASE-T cables and wiring may be used.

www.GarrettCom.com

2. Connect the other end of the cable to the corresponding device.
3. When proper connection and power have been established, the port's LINK LED will illuminate GREEN.

NOTE: The Magnum **RPM-TP** and **BPM-TP** are equipped with a crossover slide switch to accommodate repeater-to-repeater connections without special crossover connectors.

Set the slide switch to the "down" position for normal twisted pair cable segments from the hub port to a user device. Set the slide switch to the "up" position for cascaded or up-link segment connections to another repeater or hub in the network. Verify proper switch position by noting that the port's LINK LED will illuminate when proper link is established.

2.8.4 Connecting ThickNet 10BASE5 (AUI)

Using the steps below as a guide, attach a new or existing 10BASE5 ThickNet drop-cable directly to the AUI connector on the RPM-AUI or BPM-AUI port.

1. Plug the male end of the cable into the female AUI connector on the Magnum PM-AUI card.
2. Engage the AUI connector slide lock to insure maximum connectivity.
3. Connect the opposite end of the cable into a network AUI port. (This could be a network backbone transceiver, a hub or fan-out with an AUI port, or an AUI Port Module in a concentrator.)

The AUI port may also be used for connecting to other Ethernet devices using standard AUI cabling. In this type of situation, it is important to consider the AUI segment length to the attached device, including any cascading.

The maximum transmission distance between a backbone transceiver equipped with an AUI connector and the AUI port of the Magnum 3000 will vary. According to Ethernet standards, when an AUI cable is used to connect the Magnum 1000 directly to a backbone transceiver, the maximum AUI segment length of 50m (165 ft.) is allowed. If the Magnum 3000X is connected to a transceiver that has been cascaded from another transceiver, the maximum AUI segment length is reduced as stated below.

Important Note: The maximum transmission distance is decreased by 6m (20 ft.) for every additional level of network transceiver device "dropped" or "cascaded" from the original backbone transceiver tap.

The RPM-AUI connector supports standard IEEE signals, which are summarized in Table 3.3.2.

Table 2.3.2: AUI Pin Assignments

Pin	Function	Pin	Function
1	Control In Circuit Shield	10	Data Out Circuit B
2	Control In Circuit A	11	Data Out Circuit Shield
3	Data Out Circuit A	12	Data In Circuit B
4	Data In Circuit Shield	13	Voltage Plus (+)
5	Data In Circuit A	14	Voltage Shield
6	Voltage Common	15	Control Out Circuit B
7	Control Out Circuit A	SHELL	Protective Ground
8	Control Out Circuit Shield (conductive shell)		
9	Control In Circuit B		

- NOTES:**
- 1) Voltage Plus (pin #13) and Voltage Common (pin # 6) use a single twisted pair in the AUI cable.
 - 2) Pins 4, 8, 11 and 14 may be connected to pin #1.

2.8.5 Connecting ThinNet 10BASE2 (BNC)

Connect the ThinNet coax cable to the BNC connector on the Magnum RPM-BNC or BPM-BNC card in the same manner as is done for any standard BNC connection. The PM-BNC port is specially equipped with an internal termination switch on the front of the card (see Section 4.1 for a description of this switch). This eliminates the need to use a "tee" connector when the BNC cable is ending at the connection to this PM. Some applications may require a "tee" connector, used as a tap, to allow the 10BASE2 coax segment to continue on past the PM-BNC connection.

2.8.6 Connecting Drop Cable 10BASE5 (DTE)

Using the steps below as a guide, attach the 10BASE5 drop-cable directly to the DTE connector on the RPM-DTE port.

1. Plug the female end of the cable into the male DTE connector on the RPM-DTE card.
2. Engage the AUI connector slide lock (on the cable) to insure maximum connectivity.

3. Connect the opposite end of the cable into a network AUI port. (This could be a server, router, bridge, hub, or UNIX workstation.)

2.8.7 Connecting Fiber Optic 10BASE-FL and FOIRL (ST-type, "Twist-Lock")

The following procedure applies to FOIRL and 10BASE-FL applications using an RPM-ST or BPM-ST card with ST-type fiber connectors. (The primary difference between FOIRL and 10BASE-FL for users is the maximum distance allowed. 10BASE-FL is used for a fiber segment length of up to 2000m, while FOIRL is used for fiber segments of up to 1000m in length.)

1. Before connecting the fiber optic cable, remove the protective dust caps from the tips of the connectors on the PM-ST. Save these dust caps for future use.
2. Wipe clean the ends of the dual connectors with a soft cloth or lint-free lens tissue dampened in alcohol. Make certain the connectors are clean before connecting.

Note: One strand of the duplex fiber optic cable is coded using color bands at regular intervals; you must use the color-coded strand on the associated ports at each end of the fiber optic segment.

3. Connect the Transmit (TX) port (light colored post) on the Magnum PM-FST to the Receive (RX) port of the remote device. Begin with the color-coded strand of the cable for this first TX-to-RX connection.
4. Connect the Receive (RX) port (dark colored post) on the PM-FST to the Transmit (TX) port of the remote device. Use the non-color coded fiber strand for this.
5. The LINK LED on the front of the PM-FST will illuminate when a proper connection has been established at both ends (and when power is ON in the unit). If LINK is not lit after cable connection, the normal cause is improper cable polarity. Swap the fiber cables at the Port Module connector to remedy this situation.

2.8.8 Connecting Fiber Optic (SC-type, "Snap-On")

The same five-step procedure as for fiber ST-type applies to FOIRL and 10BASE-FL applications using an RPM-SC card used with SC-type fiber connectors. Follow the five steps as described in the Section 3.3.5 above.

When connecting fiber media to SC connectors, simply snap on the square male connector into the SC female jack of the device until it clicks and secures.

2.8.9 Connecting Single-Mode Fiber Optic (SMF)

When using the RPM-SMF, be sure to use single-mode fiber cable. Single-mode fiber cable has a smaller diameter than multi-mode Fiber cable (2/15 - 8/60 microns for single-mode, 50/125 or 62.5/125 microns for multi-mode where xx/xx are the diameters of the core and the core plus the cladding respectively). Because of this, single-mode fiber allows full bandwidth at longer distances, and may be used to connect nodes up to 10 Km apart.

The same five-step procedure for multi-mode fiber ST-type applies to single-mode fiber connectors. Follow the five steps listed in Section 3.3.5 above.

2.8.10 Power Budget Calculations for Magnum 3000X PM's with Fiber Media

Receiver Sensitivity and Transmitter Power are the parameters necessary to compute the power budget. To calculate the power budget of different fiber media installations using Magnum products, the following equations should be used:

$$\text{OPB (Optical Power Budget)} = P_T (\text{min}) - P_R (\text{min})$$

where P_T = Transmitter Output Power, and P_R = Receiver Sensitivity

$$\text{Worst case OPB} = \text{OPB} - 1\text{dB}(\text{for LED aging}) - 1\text{dB}(\text{for insertion loss})$$

$$\text{Worst case distance} = \{ \text{Worst case OPB, in dB} \} / [\text{Cable Loss, in dB/Km}]$$

where the "Cable Loss" for 62.5/125 and 50/125 μm (M.m) is 2.8 dB/km,

and the "Cable Loss" for 100/140 (Multi-mode) is 3.3 dB/km,

and the "Cable Loss" for 9/125 (Single-mode) is 0.5 dB/km

The following data has been collected from component manufacturer's (HP's and Siemens') web sites and catalogs to provide guidance to network designers and installers.

Fiber Port Module	Speed, Std.	Mode	Std. km fdx (hdx)	Wave - length nm	Cable Size μ m	X'mitr Output P _T , dB	R'cvr Sens. P _R , dB	Worst OPB, dB	Worst* distance Km, fdx	typical OPB, dB	typical* distance Km, fdx
RPM-MST, MSC	10 Mb FL	Multi-mode	2 (2)	850	62.5/125 100/140 50/125	-15.0 -9.5 -19.5	-31 -31 -31	14 19.5 9.5	5 5.9 3.4	17 23.5 13.5	6 7 4.8
RPM-SMF (ST)	10 Mb FL	Single-mode	10 (5)	1300	9/125	-30	-39	7	14	13	26

* *Note: The use of either multi-mode or single-mode fiber to operate at 100Mbps speed over long distances (i.e., in excess of approx. 400 meters) can be achieved **only** if the following factors are both applied:*

- *The 100Mb fiber segment must operate in full-duplex (FDX) mode, i.e. the full-duplex (factory default) setting for 100Mbps fiber ports must be used, and*
- *The worst-case OPB of the fiber link must be greater than the fiber cable's passive Attenuation.*

(Attenuation = Cable loss + LED aging loss + Insertion loss + safety factor)

2.8.11 Rack-mounting



Installation of a Magnum 3000X Hub in a 19" rack is a simple procedure.

The units are 1U (1.70") high. When properly installed, the front-mounted LED status indicators should be in plain view and easy to read. Rack-mount installation requires special 19" rack-mounted brackets and screws (included with each 3000s unit). The brackets attach to the front sides of the Hub, which is then fastened into a standard 19" RETMA rack.

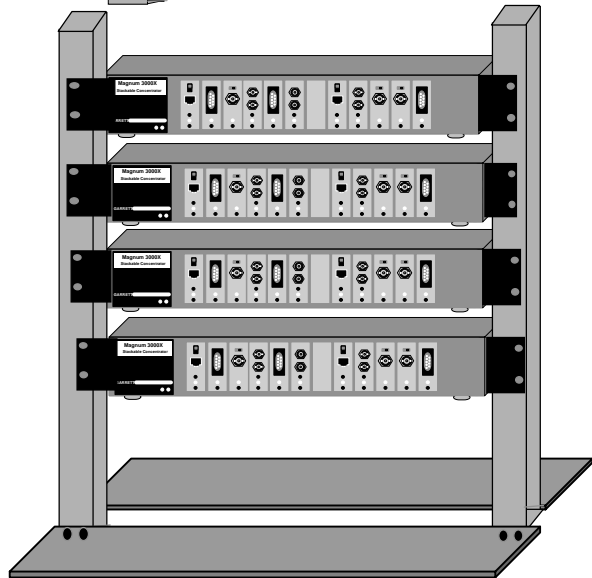

The 23" brackets and ETSI brackets are also available (optional) for Rack-mounting purpose with Magnum 3K Series Hubs. The 23" brackets are popular in the Telco industry where they are a standard for Central Office rack-mounting purposes. The 23" brackets are mainly used for larger equipment assemblies in rack-mounting frames, and are frequently accessed in operation from both sides.

The ETSI (European Telephone Standard) brackets are similar to the 19" brackets but use metric dimensions. The optional 23" brackets and the ETSI brackets come as a pair in a package, along with the necessary screws for attaching the brackets to the sides of the Magnum Hub.

Fig 3.3 Multiple Magnum 3000X units rack-mounted in a 23" frame

2.8.12 Inter-Repeater Bus (IRB) Connections

The rear of the Magnum 3000X Stackable unit has an Inter-Repeater Bus (IRB) connector on the right side. The IRB interconnects stacked units with a shielded ribbon cable, enabling all stacked Magnum 3000 units to operate as a single repeater.

There are two 34-pin IRB connectors on each unit: the bottom IRB connector is used to daisy chain the IRB to the stacked Magnum 3000X unit below (unused on bottom unit in a Magnum 3000X stack); and the top IRB connector is used to daisy chain the IRB to the stacked Magnum 3000X unit above (unused on top unit in a Magnum 3000X stack). The IRB connectors for a non-stacked unit are unused.

The IRB ribbon cables supplied with each Magnum 3000X base unit are slightly longer than the base unit height. Thus, an IRB cable segment has a small arc shape when it is properly installed. It is possible to have some long IRB ribbon cable segments, up to a few meters in length, for service loops and such. Longer IRB ribbon cables will not impair the operation of the stack. Stacks with total IRB lengths of as much as ten meters can be implemented. However, non-standard IRB cable lengths must be specially made.

The IRB ribbon cables may be installed and/or removed while a Magnum 3000X unit is powered without causing damage to the electronic circuits in that unit or any others in a Magnum 3000X stack. This is convenient for expanding a stack without shutting down the network, and for performing diagnostics and service on potentially faulty units operating in a stack. **CAUTION:** disconnecting an IRB ribbon cable can cause operational upsets by breaking the interconnection among the stacked units previously operating as a single repeater and/or with one SNMP agent.

2.8.13 Segmenting a Magnum 3000 Stack with a Special Segmenting Cable

Magnum 3000X Stackable Concentrators are typically stacked as described in Section 2.8.10. However, it may be desirable to stack the 3000s so that they operate as separate repeater units. This will normally be done to manage several separate hubs (or small stacks) with a single 3000 AGT SNMP Agent box. In this situation, single units or several small stacks of units may be connected using SRC Segmenting Cables (part numbers SRC-2 and SRC-4, available as a spare part from GCI). Hubs connected via an IRB Segmenting Cable do not transmit or receive normal Ethernet traffic through the IRB.

GCI supports this non-standard configuration, making special stacking cable available (see Models SRC-2 and SRC-4 in the Spare Parts Price List) to provide the flexibility to break apart managed stacks into multiple collision domains for higher performance, while still maintaining the advantages of one SNMP agent.

Consider the case where it is desired to divide a managed stack into two segments and insert a local bridge to increase performance (see Figure 2.3.2a). Normally, it would be necessary to add another SNMP agent to maintain full management. However, using the special Segmenting cable option, it is possible to remove one standard IRB cable and replace it with an SRC cable. This divides the stack into two logical repeaters with separate collision domains, while still passing SNMP management data through the SRC so that the agent can manage both repeaters. Then, a local bridge can be installed between the two repeaters using a port from each (for example, using a bonus port from each repeater) to provide traffic service between the repeaters while maintaining full 10Mbps bandwidth for the users on each repeater stack.

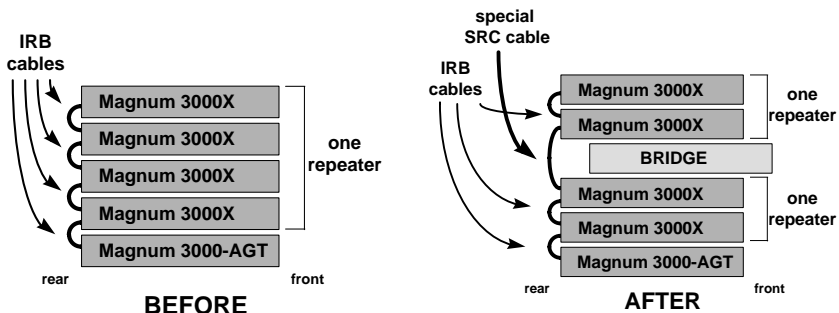

Figure 2.8.13a: Stack segmentation using an

SRC Cable

Installing a Magnum Bridge Port Module (BPM) into the Bonus Port of one of the repeaters and connecting it to a port on the other repeater could also achieve the same result.

In another example, eight 3024 hubs in a managed stack are individually segmented and a switching hub is used as the traffic center.

This special configuration provides high bandwidth for the users on each 3024 hub, but also provides the efficiency of a single SNMP agent for all of the 3024s. Note also that Magnum 3012 and 3000X units

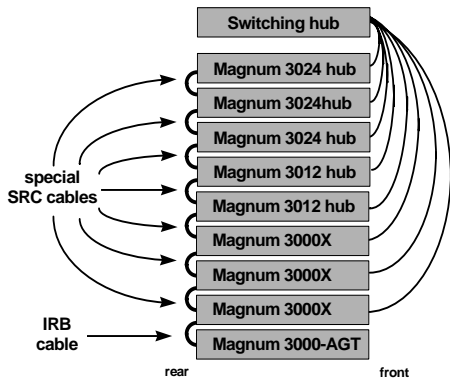

Figure 2.8.13b: SRC cables segment a managed stack for connection to switching hub ports

can be used with the special SRC segmenting cable, mixing with the 3024 models in configurations as desired.

NOTE: To differentiate the SRC cable from the IRB cable, GCI uses colored ribbon cable for the SRC. The standard IRB cables are gray in color.

2.8.14 SNMP Agent's Connections

Refer to Chapter 4 for information on SNMP Agents.

2.9 Port Module (PM) Installation

The Magnum 3000X is normally received from the factory with all required PM modules installed. There may be situations where PM cards need to be added or replaced. In cases where additional PM cards are needed, the faceplate for an available front-mounted slot must be removed.

The following procedure describes this operation.

STOP!!!

Be sure the power cord is unplugged from the chassis before attempting to remove and/or replace a PM card. Failure to do so may result in damage to the unit and will void the warranty.

2.9.1 Preparation for Installing and Removing PMs**Step 1. Remove Chassis Cover**

There are 7 screws located on top and 3 on the top-front of the unit. Remove these screws. Once these are removed, the cover is easily lifted off the chassis base.

When the chassis cover has been removed, the interior of the unit is exposed.

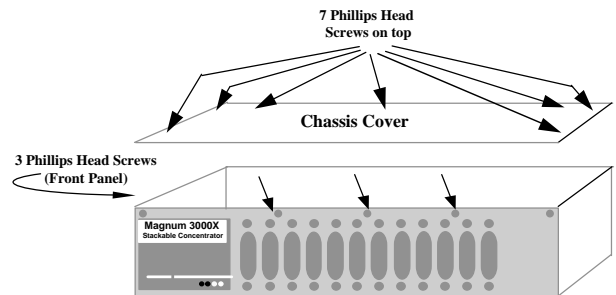
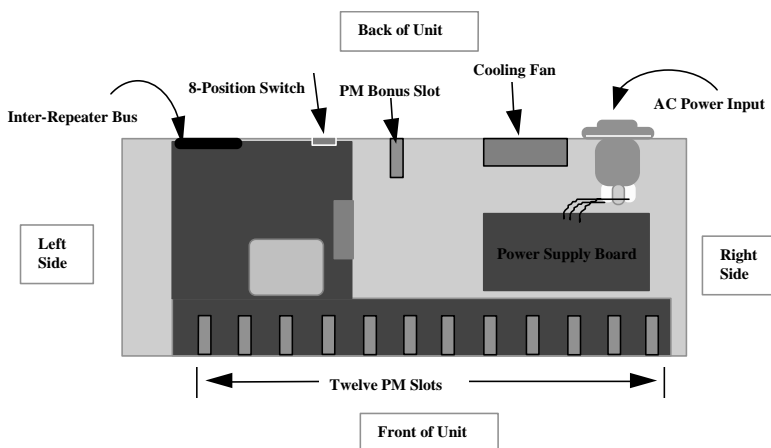

Figure 2.9.1a: Removing Chassis Cover

Caution: Be careful not to disturb the power supply.



Looking down into the Magnum 3000X unit, notice that there are individual PM connector sockets for each PM card position. There are 12 slots on the front of the unit and a bonus slot on the rear of the unit. A total of thirteen slots for thirteen Ethernet segments are available. (See Figure 3.9.1b).

Figure 2.9.1b: Magnum 3000X, Top View with Chassis Cover Off

Step 2. Remove Face Plate Retaining Screws

On the front of the unit there are two retaining screws for each PM card slot. These screws are used to secure a PM faceplate in position. These screws are also used to secure the individual PM modules, which can be subjected to significant forces from the attached cables. (See Figure 2.9.1c)

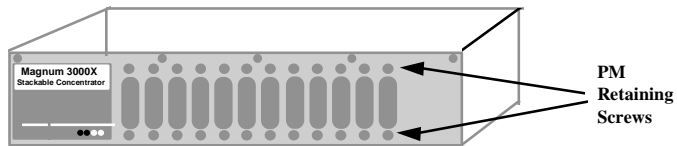

Figure 2.9.1c: Front View - PM Retaining Screws

PM card installation is covered in Section 2.10. PM card removal is covered in Section 2.11.

2.10 Installing PM Cards in the Magnum 3000X

Up to twelve front-mounted PM cards may be installed in one Magnum 3000X Stackable Concentrator unit. Follow these steps to install a PM.

Step 1. Remove chassis cover. See procedure in Section 3.9 above.

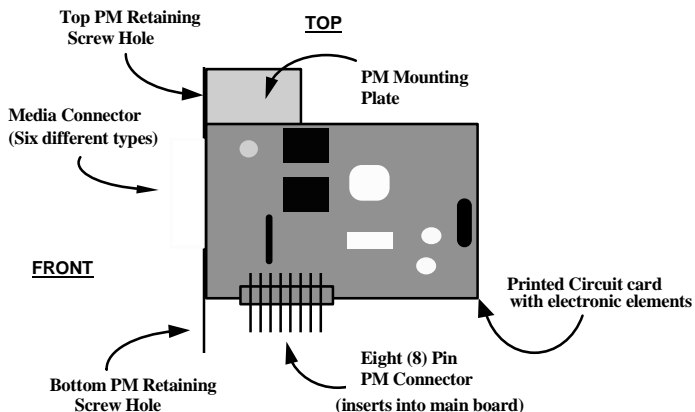

Step 2. Figure 3.10a illustrates the basic layout of an individual PM card. Each PM card fits easily into the applicable PM connector socket slot. Align the connector pins on the bottom of the PM card with the connector socket inside the unit.

Figure 2.10a: Side View of a PM Card

Step 3. Slowly and firmly push the PM into position (see Figure 3.10b below). Once inserted, secure the PM card using the two screws on the front panel of the unit.

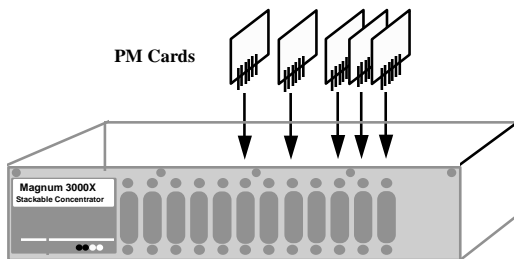

Figure 2.10b: Inserting PM Cards into a Magnum 3000X

NOTE: All PM slots need not be filled in order for the Magnum 3000X unit to be operational. When leaving PM slots empty, always use a face plate Magnum (PM-FP) to cover the slot opening in the front panel in order to maintain proper cooling air flow, and for safety.

Step 4. Once all PM cards have been installed (including face plates for empty slots), the chassis cover should be replaced.

2.11 Removing PM Cards

To properly remove a PM card from the Magnum 3000X Stackable Concentrator follow the three steps below.

Step 1. Remove chassis cover

See procedure in Section 2.9 above.

Caution: Be sure the power cord is unplugged.

Step 2. Remove front retaining screws for the PM

On the front of the unit there are two retaining screws for each PM card slot. These screws are used to secure a PM card in position (see Figure 2.11a). Remove the front screws of the PM to be removed.

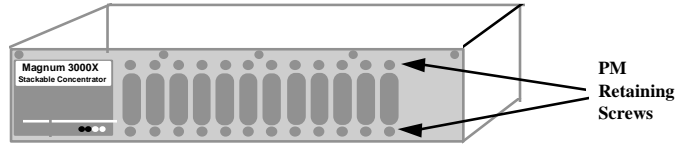

Figure 2.11a: Front View - PM Retaining Screws

Step 3. Remove PM Card

Gently pull the PM card up and out of the connector socket (see Figure 2.11b). If the slot from which the PM card has been removed is to remain unused, be sure to install a PM faceplate cover in it. If another PM card is replacing the one that has been removed, follow the steps as described for installing a PM card discussed in Section 2.10 on the preceding pages.

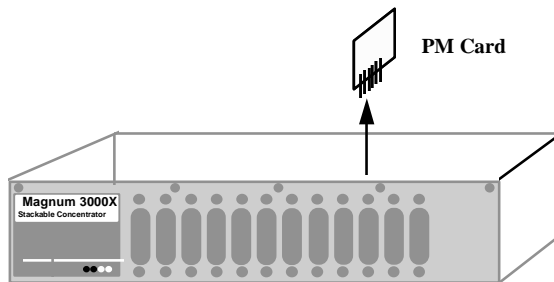

Figure 2.11b: Removing a PM Card

2.12 Operation

The operation of the Magnum 3000X is described in this section.

2.12.1 Repeater Functionality

The Magnum 3000X operates as a mixed media Ethernet concentrator to support multiple segments within a single collision domain. It is compliant with IEEE 802.3 specifications and supports all IEEE defined media, including of 10BASE-T, 10BASE-FL, FOIRL, 10BASE2, and 10BASE5. The following describes the basic functionality of the Magnum 3000X stackable concentrator.

- 1. Repeater Functions:** Each RPM card port operates in conjunction with the controller functions of the 3000X chassis as a fully compliant Ethernet repeater. The entire concentrator unit (or a stack of multiple units) counts as a single repeater.
- 2. Collisions:** When a collision is detected at a port other than the original receiving port, it generates a jam pattern to the other ports. When a collision signal is detected at a receiving port, it generates a jam pattern to the other ports. The sequence of jam signals depends on the sequence and location of collisions.
- 3. Partitioning and Re-connection:** An unmanaged Magnum 3000X will automatically disconnect (partition) any segment (port) when 64 consecutive collisions occur or after 6.5 ms of continuous transmissions. Network integrity is checked every 800 ms and segment (port) reconnection occurs after a 512-bit packet is transmitted without error.
- 4. Link Status:** The Magnum RPMs indicate link integrity for fiber optic and twisted pair segments. LINK is normally lit. Broken cables or a loss of power at any point in such segments will turn off the LINK LED.

2.12.2 BPM Local Bridge Functionality

When configured with a BPM, a Magnum 3000X and its attached nodes are effectively isolated from the network segment connected through the BPM. The bridge functionality of the BPM bridge modules is described here.

- 1. Bridge Functions:** Each BPM card contains a compact local bridge module which filters and forwards packets at full Ethernet wire speed. These micro-bridges are self-learning and have small (256 user) address tables.

Packet filter/forward decisions are made based on whether the packet source is internal (originates within the local Magnum Hub/Stack) or external (originates from upstream on the attached segment). If the packet's source is internal, it is forwarded to the outside only if the

www.GarrettCom.com

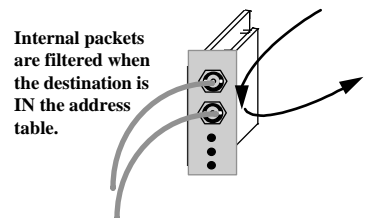
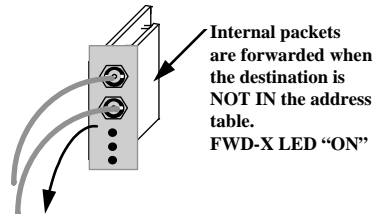

destination address is not in the address table. Figure 2.12.2a shows an internal packet being forwarded to the external segment. **Figure 2.12.2a:**

Internal Packet Forwarded

Figure 2.12.2b show the cases where an internal packet is filtered.

When the packet's source is external (see next page), it is forwarded to the inside only if the destination address is in the address table. **Figure**

2.12.2b: Internal Packet Filtered

The filter/forward handling of external packets are shown in figures 2.12.2c and 2.12.2d respectively. When an internal packet's

source address is not already

in the address table, it is

Figure 2.12.2c: External Packet Forwarded

written there. This happens when a node first sends a packet after bridge initialization. Note, therefore, that the BPM address table learns only internal addresses, i.e., those inside of the local Magnum

Hub/Stack, a number typically well under the 256-table addresses size.

Should the table become full, the BPM will clear all entries in the table by reinitializing itself.

When an external packet's source address is found in the address table, it is purged. This might occur if a

node **Figure 2.12.2d: External Packet Filtered** has physically changed its location. A summary of the filtering, forwarding, and address table maintenance performed by the BPMs is in Table 2.12.2.

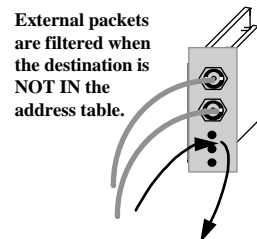
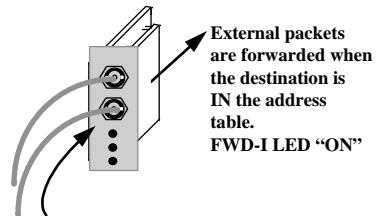

Table 2.12.2: BPM Functionality

Packet Source	Source Address	Destination Address	Address Table Maintenance	Filter/Forward Action
Internal	Not in table	Not in table	Add source to table	Forward
Internal	Not in table	In table	Add source to table	Filter
Internal	In table	Not in table	Nothing	Forward
Internal	In table	In table	Nothing	Filter
External	Not in table	Not in table	Nothing	Filter
External	Not in table	In table	Nothing	Forward
External	In table	Not in table	Purge source from table	Filter
External	In table	In table	Purge source from table	Forward

2. Throughput Increase: By using a BPM to isolate a user group segment having significant local traffic, it is possible to increase overall network throughput. For example, a segment containing a group of workstations and servers may have heavy local traffic, but only a small amount of traffic that is directed outside the local segment. A BPM connecting this local segment to the rest of the network, as shown in Figure 2.12.2e, will keep the local segment traffic bridge-isolated from the rest of the network, thus increasing the effective bandwidth on both the local segment and the rest of the network.

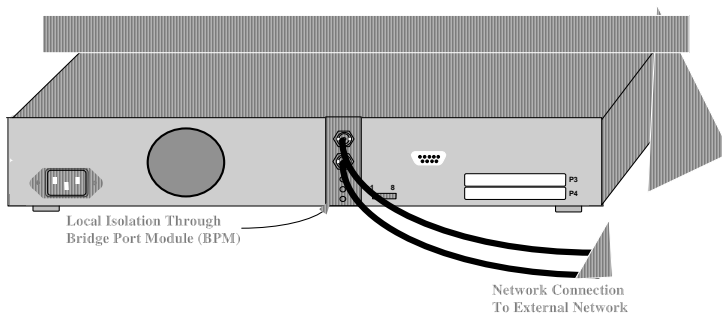

Figure 2.12.2e: Local Isolation with BPM Bonus Port Configuration

- 3. Bridge Transparency:** The BPMs are transparent to both the user and the application software.

- 4. LINK Status:** The Magnum BPM-TP and BPM-FST indicate link integrity with an LED. This LINK LED is normally lit. An unlit LINK LED indicates a broken cable or loss of power at some point in the segment.
- 5. Traffic Status:** All BPMs have FWD-I and FWD-X status LEDs. The FWD-I LED flashes when external packets from up-stream are forwarded into the local segment. The FWD-X LED flashes when local packets are forwarded up-stream, out of the local segment to external nodes.
- 6. Self-test Diagnostics:** A BPM performs an internal self-test upon power-up. This test last approximated 4 microseconds, and is not noticeable to the user. When bridging operation starts, the FWD-I and FWD-X LEDs on the BPM's front plate will indicate traffic activity by flashing.

2.13 Powering the Magnum 3000X

The Magnum 3000X incorporates an internal universal power supply, and has a male IEC connector for the AC power cord at the right rear. A six foot 115 vac power cord is supplied with each unit. (Units shipped from the GCI factory to outside the United States and Canada will not include a 115-vac power cord.)

The Magnum 3000X supports installation environments where the AC voltage ranges from 90 - 260 volts with a power input frequency of between 47 - 63 Hz and will consume no more than a maximum of 65 watts. The power connector is located on the back of the unit. In order to power down the unit, simply unplug the unit's power cable in a stacked configuration (this will NOT affect the operation of other units in the stack).

When connecting various Ethernet media, there is no need to power down the 3000X unit. Individual segments of any media type can be connected or disconnected from PMs without concern for AC power -related problems or damage to the unit.

2.14 Chassis LEDs

The Magnum 3000X is equipped with four LEDs located on the front of the chassis unit. These LEDs include Power (PWR), Receive (RX), Collision (COL) and Jabber (JAB). They are used to provide visual indication about the operational condition and traffic activity of the 3000X unit and its associated PM cards.

Magnum 3000X chassis unit LEDs

<u>LED</u>	<u>Description</u>
PWR	Illuminates GREEN to indicate that the unit is receiving power.
RX	GREEN, ON when data is being received on 1 or more PM ports.
COL	Flashes YELLOW to indicate a collision has occurred.
JAB	Illuminates AMBER to indicate a jabber condition has occurred.

Along with the Magnum 3000X chassis, each PM card features a set of LEDs.

See chapter 3 for a description of each PM and its LEDs.

3.0 Introduction - Magnum Port Modules

This chapter describes each Port Module (PM), including appearance, functionality, and status displays.

3.1 Inspecting the Package and Product

This section applies only to PMs shipped as separate items, i.e., PMs not factory installed in a Magnum 3000X PM slot or in bonus port slots.

Examine the shipping container for obvious damage prior to installing a PM; notify the carrier of any damage, which you believe occurred during shipment or delivery. Inspect the contents of this package for any signs of damage and ensure that the items listed below are included.

This package should contain:

One or more PMs.

Remove the PM(s) from the shipping container. Be sure to keep the shipping container should you need to ship any of the PMs separately at a later date.

In the event there are items missing or damaged contact your supplier. If you need to return the unit, use the original shipping container if possible. Refer to Chapter 6 for specific return procedures.

3.2 Product Description

An important feature of the Magnum 3000X Concentrators (and also of other

www.GarrettCom.com

Magnum X-Line products) is the use of individual Port Modules (PMs) for flexible mixed-media connectivity. The Magnum PMs are compact interface cards designed to support every standard Ethernet media type. Each PM provides one port for connecting one Ethernet segment with its individual connector type and media. There are a total of six Repeater Port Module (RPM) cards, plus a faceplate. They are:

RPM-BNC	RPM-AUI	RPM-DTE
PM-FST (or FSC)	RPM-SMF	PM-TP

There are also four different Bridge Port Module (BPM) cards. They are:

BPM-BNC	BPM-AUI	BPM-TP	BPM-FST
---------	---------	--------	---------

Each PM is individually described as follows.

3.2.1 RPM-BNC

The Magnum RPM-BNC repeater module is equipped with a standard 10BASE2 coax connector. This RPM performs full IEEE 802.3 repeater functionality and is used for 10BASE2 ThinNet (commonly referred to as BNC) connections.

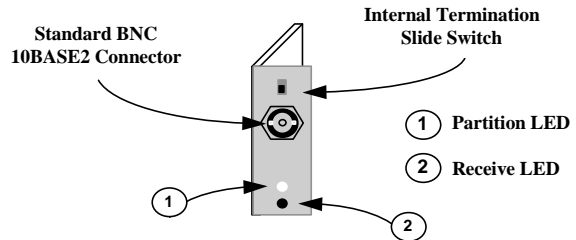

The RPM-BNC module is designed with a special switch-selectable internal termination function that eliminates the need for a "tee" connector and a 50-ohm terminator. To take advantage of internal termination, the slide switch should be in the "DOWN" (or right-side) position. In this configuration, the 10BASE2 segment is directly attached to the BNC port where it is internally terminated. When the switch is in the "UP" (or left-side) position, the BNC port requires a "tee" connector (not supplied) and a 50-ohm terminator for proper termination. Certain applications may require a "tee" connector, used as a tap, to allow the 10BASE2 coax segment to continue on past the RPM-BNC connection.

The RPM-BNC module includes one partition (PART) and one receiver (RX)

LED, which are visible from the front. The PART LED illuminates AMBER to indicate that the segment has been automatically partitioned. As soon as normal reception resumes, the segment will be automatically re-established. The RX LED illuminates GREEN intermittently to indicate data is being received.

Important Note: for the RPM-BNC Termination Switch - DOWN (or right): Internally Terminated UP (or left): Requires "T" Connector.

3.2.2 RPM-AUI

The RPM-AUI is equipped with a 15 pin female AUI connector and a slide-lock, and performs full IEEE 802.3 repeater functionality. It is used to provide connectivity with a 10BASE5 (ThickNet) backbone or to any AUI segments. A transceiver is required when connecting to a ThickNet segment and the RPM-AUI supports this convention. The RPM-AUI is also a "universal" Ethernet media interface as it may be used with a variety of different mini-transceivers to provide connectivity to any media type.

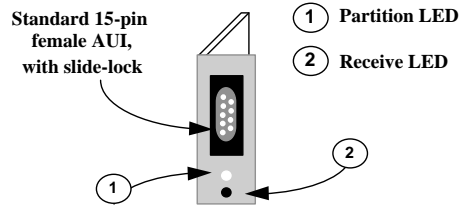

Magnum RPM-AUI

NOTE: When the RPM-AUI is factory configured as a bonus port, it is implemented as an AUI connector with a ribbon cable to special pins on the main board. The functionality of this is identical to the RPM-AUI.

The RPM-AUI card is equipped with Partition (PART) and Receive (RX) LEDs, which function the same as the identical LEDs on the RPM-BNC (see above).

The Magnum RPM-AUI card is also used for connecting Ethernet devices

using standard AUI cabling. In this situation, it is important to consider the AUI segment length or distance to the attached device.

The maximum transmission distance between a backbone transceiver equipped with an AUI connector and the Magnum RPM-AUI card will vary. When an AUI cable is used to connect the Magnum RPM-AUI directly to a backbone transceiver, the maximum AUI segment length is allowed. If the Magnum RPM-AUI is connected to a transceiver that has been cascaded from another transceiver, the maximum AUI segment length is reduced.

According to Ethernet standards, the maximum distance from the transceiver AUI connector and the attached device (Magnum RPM-AUI) is 50m (165 ft.). The AUI segment maximum length is reduced in cascaded configurations. See the following note.

Important Note: The maximum transmission distance is decreased by 6m (20 ft.) for every additional level of network transceiver device "dropped" or "cascaded" from the original backbone transceiver tap.

The RPM-AUI connector supports standard IEEE signals, which are summarized in Table 4.2.2.

Table 4.2.2: AUI Pin Assignments

Pin	Function	Pin	Function
1	Control In Circuit Shield	10	Data Out Circuit B
2	Control In Circuit A	11	Data Out Circuit Shield
3	Data Out Circuit A	12	Data In Circuit B
4	Data In Circuit Shield	13	Voltage Plus (+)
5	Data In Circuit A	14	Voltage Shield
6	Voltage Common	15	Control Out Circuit B
7	Control Out Circuit A	SHELL	Protective Ground
8	Control Out Circuit Shield (conductive shell)		
9	Control In Circuit B		

NOTES:

- 1) Voltage Plus (pin #13) and Voltage Common (pin # 6) use a single twisted pair in the AUI cable.
- 2) Pins 4, 8, 11 and 14 may be connected to pin #1.

3.2.3 RPM-DTE

The Magnum RPM-DTE is a module equipped with a 15-pin male DTE connector with lock posts. (The RPM-DTE is a mating connector for the RPM-AUI, which has a 15-pin female connector, and slide locks. The pin assignments of

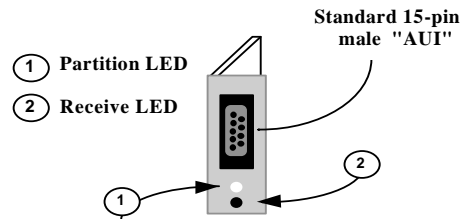

Magnum RPM-DTE

the two are the same). The RPM-DTE card is designed to support direct connections (no transceiver required) using AUI drop cables to any device that is equipped with an AUI port. Examples of such devices include servers, routers, bridges, hubs, and UNIX workstations.

3.2.4 RPM-FST (Fiber ST, Twist-lock Connector)

The Magnum RPM-FST is a multi-mode fiber optic module equipped with a dual ST-type connector. It functions as an IEEE 802.3 full repeater to support 10BASE-FL and FOIRL network segments. When used for 10BASE-FL segments, this module supports fiber optic transmission distances up to 2000m. For FOIRL applications, it supports fiber segments of up to 1000m in length. The RPM-FST includes full transceiver functionality

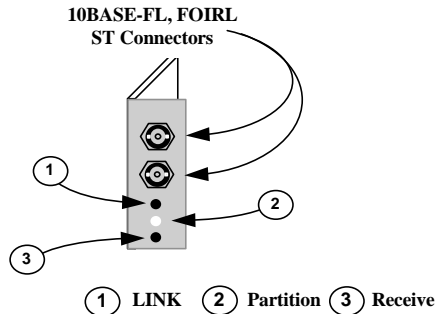

Magnum RPM-FST

and does not require an external transceiver device. In addition to Partition (PART) and Receive (RX) LEDs, a LINK LED indicates proper connectivity with the remote device.

NOTE: The RPM-FST/FSC circuit board contains a six-pin jumper, which controls the intensity of the transmitted signal. By default, the jumper is placed across pins 1 and 2.

The jumper may be set as follows to accommodate distances of up to 4 km:

JUMPER ACROSS DISTANCES SUPPORTED

1 - 2	0 - 2 km
3 - 4	0.5 - 3 km*
5 - 6	1.5 - 4 km*

When distances of less than 2 km are needed, the jumper should be placed across pins 1 and 2.

*When fiber cable distances of more than 2 km are selected, the minimum cable length must also be increased, as shown in the table above.

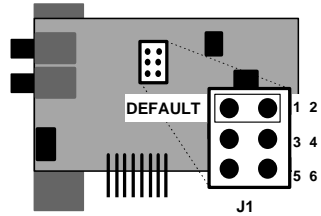

3.2.5 RPM-FSC (Fiber SC, Snap-in Connector)

The Magnum RPM-FSC is also a multi-mode fiber optic repeater module, similar to the RPM-FST. It has the same LEDs indicating port partitioned (PART), receive activity (RX), and link operational (LINK). It has the same jumper settings for extra distance in certain circumstances.

While the functionality of the these two modules is the same, the RPM-FSC is equipped

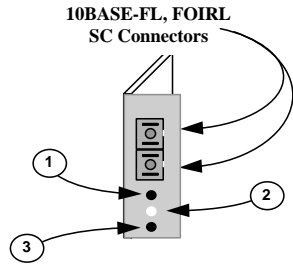

Magnum RPM-FSC

with an SC-type "snap-in" connector instead of an ST-type "twist-lock" connector. Please refer to Section 3.2.4. for details.

3.2.6 RPM-SMF (Single-mode Fiber)

The Magnum RPM-SMF is a single-mode fiber optic module equipped with a dual ST-type connector. It functions as a full repeater to support single-mode fiber networks. The RPM-SMF supports fiber optic transmission distances of up to 10 Km. The RPM-SMF includes full

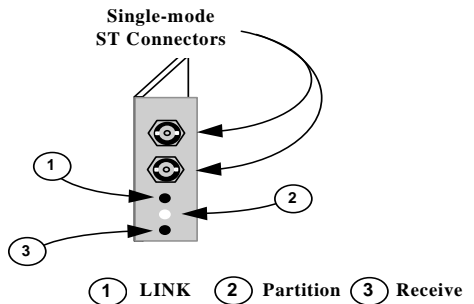

transceiver functionality and does not require an external transceiver device.

This module is equipped with PART, RX, and LINK LEDs identical to those of the RPM-FST.

Magnum RPM-SMF

To distinguish the single-mode RPM-SMF from the multi-mode RPM-FST, the label “Sgl. M.” is at the top of the faceplate of the RPM-SMF. As an additional indicator, a multi-mode TX port emits light (red in color) that is in the visible spectrum and which can be seen by looking into the port with the power on and with no cable connected. The single-mode TX port emits light outside of the visible spectrum and will always look dark to the human eye.

Note: Be sure to use single-mode fiber optic cable with this module (see Section 3.8.9). Single-mode fiber cable has a smaller diameter than multi-mode fiber cable (2/15 - 8/60 microns for single-mode, 50/125 or 62.5/125 microns for multi-mode, where xx/xx are the diameters of the core and the core plus the cladding respectively).

NOTE: The RPM-SMF circuit board contains a six pin jumpers, but the jumper is only to be placed across pins 5 & 6. Others are not used.

JUMPER ACROSS DISTANCES SUPPORTED

1 - 2	0 - 10 km
3 - 4	not used
5 - 6	not used

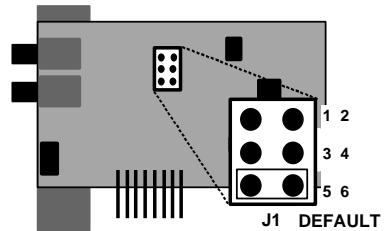

3.2.7 RPM-TP (Twisted Pair)

The Magnum RPM-TP card supports Ethernet twisted pair segments of any standard length. It is equipped with a single RJ-45 connector. The RJ-45 connector is shielded to minimize emissions and will allow both unshielded twisted pair (UTP) and

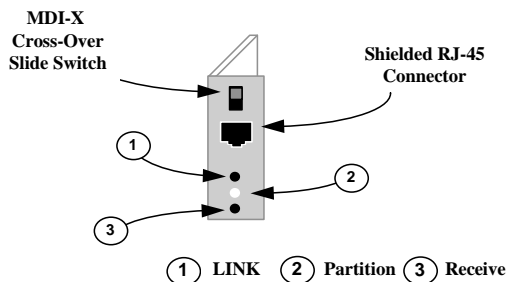

shielded twisted pair (STP) segment connections.

Magnum RPM-TP

The RPM-TP module is also equipped with a Media Dependent Interface-Crossover (MDI-X) slide switch to allow for cascaded connections. This feature eliminates the need for a special twisted pair crossover cable.

With the switch in the UP position, the RPM-TP port is used for cascaded and up-link connections (i.e.: a connection to another repeater or hub or concentrator typically.) When used for segments going to workstations and other user device connections, the MDI-X switch should be in the DOWN position.

The RPM-TP will support 10BASE-T unshielded twisted pair wiring (UTP) environments with maximum segment distances up to 100m (325 ft.), or shielded twisted pair wiring (STP) of 150m (500 ft.). This module is designed with internal transceiver functionality. The RPM-FST has LINK, PART, and RX LEDs.

Important Note: For the RPM-TP MDI-X Crossover Switch - DOWN (or Right) for workstations and user connections. UP (or Left) for Up-Link connections to other hubs, etc.

(To help recall the right TP switch position, remember "up for up-link"!)

The RJ-45 pins normally (TP crossover switch DOWN) are per the standard for hubs-to-users twisted pair wiring: 1 = receive+, 2 = receive-, 3 = transmit+, 6 = transmit-, other pins not used. When the TP crossover switch is UP, the pins of the RJ-45 port are per the standard for up-links using twisted pair wiring, i.e., the transmit and the receive pairs are exchanged: 1 = transmit+, 2 = transmit-, 3 = receive+, 6 = receive-, other pins not used.

3.2.8 PM-FP

The PM-FP is a blank faceplate that is installed in any empty PM slot. When the Magnum 3000X chassis contains less than twelve front-mounted PMs, the empty front slots must be covered with the PM-FP faceplate in order to maintain proper cooling airflow, and for safety.



Note: The Magnum PM-FP must be installed in each empty PM slot.

Magnum PM-FP

3.2.9 BPM-BNC

The Magnum BPM-BNC bridge module is equipped with a standard 10BASE2 coax BNC connector. This BPM is self-learning and filters and forwards packets at full Ethernet wire speed. This module is used for 10BASE2 connections and is designed to isolate the local segment (i.e., the local nodes connected to the Magnum unit housing the BPM internally) from the connecting network (i.e., the nodes of external users and devices connected through the BPM's media connector).

The BPM-BNC module is designed with a special switch -selectable internal termination function that eliminates the need for a "tee" connector and a 50 ohm terminator. For switch details, refer to the RPM-BNC section, 3.2.1

The BPM-BNC module includes an FWD-I LED and an FWD-X LED, which are visible from the front. The FWD-I LED blinks GREEN to indicate that packets are being forwarded INTO the local Magnum hub or stack. The FWD-X LED blinks GREEN to indicate that packets are being forwarded OUT of the local Magnum hub or stack.

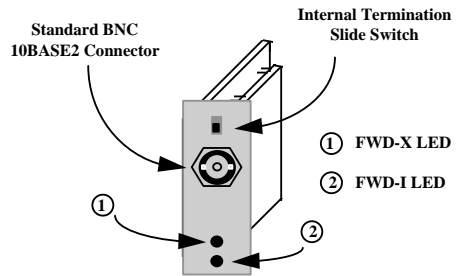

Magnum BPM-BNC

3.2.10 BPM-AUI

This local-bridge module is equipped with a 15 pin female AUI connector and a slide-lock. It is self-learning and filters and forwards packets at full Ethernet wire speed. It is used to provide segment isolation from a 10BASE5 (ThickNet) backbone or any AUI segments. A transceiver is required when connecting to a ThickNet segment and the BPM-AUI supports this convention.

The BPM-AUI card is equipped with one FWD-I LED and one FWD-X LED, which are identical to those of the BPM-BNC (Section 3.2.9). **Magnum BPM-AUI**

The RPM-AUI connector supports standard IEEE signals, which are summarized in Table 3.2.2 of Section 3.2.2.

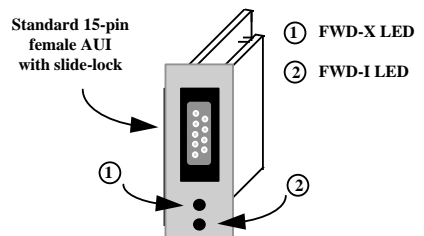

3.2.11 BPM-FST

The Magnum BPM-FST is a multi-mode fiber optic local-bridge module equipped with a dual ST-type connector. It is self-learning and filters and forwards packets at full Ethernet wire speed.

When used for 10BASE-FL segments, this module supports fiber optic transmission distances up to 2000m. For FOIRL applications, it supports fiber segments of up to 1000m in length. The BPM-FST includes full transceiver

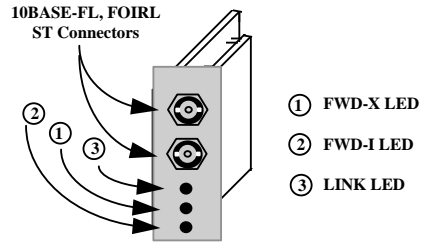

Magnum BPM-FST

functionality and does not require an external transceiver device. The BPM-FST has three status LEDs. FWD-I and FWD-X is identical to those of the BPM-BNC (Section 4.2.9). In addition, this module has a GREEN LINK LED, which is always on when the attached fiber link is operational.

3.2.12 BPM-TP

The Magnum BPM-TP card is equipped with a single RJ-45 connector and supports Ethernet twisted pair segments of any standard length. The RJ-45 connector is shielded to minimize emissions and will allow both unshielded twisted pair (UTP) and shielded twisted pair (STP) segment connections.

The BPM-TP module is also equipped with a Media Dependent Interface-Crossover (MDI-X) slide switch to allow for cascaded connections. This feature eliminates the need for a special twisted-pair crossover cable. For MDI-X switch details, refer to the RPM-TP section,

3.2.7.

The BPM-TP will support 10BASE-T unshielded twisted pair wiring (UTP) environments with maximum segment distances up to 100m

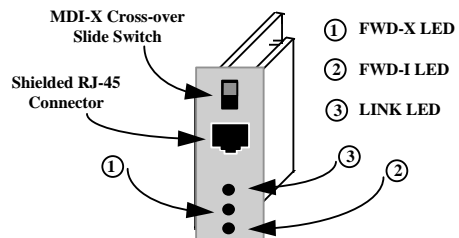

(325 ft.), or shielded twisted pair wiring (STP) of 150m (500 ft.). This module is designed with internal transceiver functionality. The LINK, FWD-I, and FWD-X LEDs of this BPM are the same as those of the BPM-FST (Section 3.2.11).

Magnum BPM-TP

3.3 Installation of PMs

Refer to the PM installation sections in Chapter 3 for instructions on installing; removing or exchanging individual PM cards in Magnum 3000 units.

4.0 Introduction - Simple Network Management Protocol (SNMP) Agents

This chapter describes the Magnum 3000X SNMP agent products.

4.1 SNMP Agents Description

There are two configuration options (versions) of the Magnum SNMP hardware agent. Both versions follow standard MIB I and MIB II protocol conventions.

In one version, the Magnum SNMP agent is offered as an embedded board (Model 3000-MB), which resides directly within the Magnum 3000X box. In the alternate version, the Magnum SNMP agent board is available in a separate box (Model 3000-AGT) that is the same size as a 3024 or 3012 unit, and has its own internal power supply and Inter Repeater Bus (IRB) connections to fit it into a Magnum 3000 stack. The "MB" version is ideal for agents that are part of the initial configuration, and for the smaller stacks and single-unit systems. The "AGT" version is convenient for field additions of the SNMP agent option and for large stacks.

Magnum SNMP agents support all standard basic SNMP commands (GetRequest, GetNextRequest, GetResponse, SetRequest and Trap), and allow monitoring and changing of the target device's configuration and parameters as well as reporting the device alarms from a network management station.

4.1.1 Embedded SNMP Agent, Model 3000-MB

The embedded Magnum SNMP agent is a daughter board that is directly attached to the master printed circuit board inside each 3000X unit. The embedded agent essentially consists of an embedded computer configuration built around a 386 CPU, and is designed with an interface to the Inter-Repeater-Bus (IRB). This allows all

units within a Magnum stack to be managed from a single SNMP agent via the IRB that interconnects the stack.

The embedded agent board is equipped with an externally accessible 9-pin RS-232 serial connector, referred to as "P1". This connector may be used to set the IP address and configuration files of the Magnum agent if necessary.

EPROMs on the agent board contain fixed data and program firmware. The Standard Repeater MIB (MIB I & MIB II) and the Monitor and Address Tracking MIB extensions data are in this firmware. The firmware in the EPROMs performs the data collection and execution functions, and operates as the local controller and interface to the network manager.

4.1.2 Separate Agent Box, Model 3000-AGT

The Magnum 3000 SNMP Agent Box operates the same as the embedded board agent. It is packaged as a separate unit, enclosed in a box that is the same dimensions as a 3024 or 3012 so that it fits neatly into a Magnum 3000 stack. It is a complete modular unit with its own internal auto-ranging power supply.



Figure 4.1a: Magnum 3000 Agent Box, Model 3000-AGT, Front View

The Inter- Repeater Bus (IRB) connects the Magnum 3000-AGT-agent box into a stack. There are two IRB connectors at the right rear, permitting the agent box unit to be installed at the bottom or top of a stack using one IRB connector, or to be inserted into the middle of a stack using two IRB connectors. The IRB cable connectors are made with "notches / keys" to insure a proper connection.

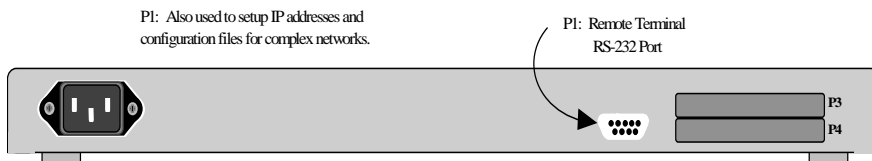

Figure 4.1b: Magnum 3000 Agent Box, Model 3000-AGT, Rear View

The agent logically resides on the IRB and will not be visible to network management software packages as a separate port or user. For network integrity, the

agent is designed so that network managers cannot disconnect it accidentally or purposefully. Similarly, the agent operates in the stack attached to the IRB and does not need to use a port in any Magnum 3000 unit or any other unit to be connected.

4.1.3 Standard Repeater MIB and Extensions

Both the Magnum 3000-MB and 3000-AGT SNMP Agents are in compliance with MIB1, MIB2, and the RFC 1368 Standard Repeater MIB, and fully support all Repeater MIB functionality as defined by IEEE 802.3 specifications. In addition to the basic Standard Repeater MIB, the Magnum 3000 SNMP Agents include the Port Monitor and Port Address Tracking MIB extensions. Magnum SNMP Agents also comply with RFC 1155-SMI, RFC 1212, RFC 1213-MIB, and RFC 1215.

The completeness of the Magnum SNMP Agents allows for in depth network statistics generation and monitoring by LAN manager software products. While the basic Standard Repeater MIB only provides repeater statistics, the MIB Monitor extensions allow for individual port statistics, including readable frames and octets, FCS errors, alignment errors, runts, collisions, as well as other performance-related port conditions. These MIB Monitor extensions can prove helpful as diagnostics in many ways, such as understanding why a port is not receiving packets.

The Magnum SNMP Agents' Address Tacking MIB extensions allow the LAN manager to poll for the source address of the most recent packet received on an individual port, as well as the number of times the source of the port's packets has changed. This feature is useful in the compilation of network traffic statistics, since the LAN manager is able to see not only how many frames were received, but also where they came from. (This may be very helpful in determining the need for local segment isolation by means of a local bridge or BPM.)

Most SNMP network management software packages (including Castle Rock's "SNMPc" product) allow both the standard repeater and enhanced port statistics to be viewed as a graph, chart or table.

In addition to statistics compilation, Magnum SNMP Agents also allow the LAN manager software to remotely disable ports if necessary. For example, it may be necessary to temporarily remove ports from the network, such as during network testing. With the Magnum SNMP Agents Standard Repeater MIB commands, this can easily be accomplished through the LAN manager software.

A list of specific commands supported by the Magnum SNMP agent appears in Table 4.1.3.

Table 4.1.3: Magnum SNMP Agent Commands

<u>Variable</u>	<u>Type</u>
Repeater ID	ATTRIBUTE GET
Repeater Group Capacity	ATTRIBUTE GET
Group Map	ATTRIBUTE GET
Repeater Health State	ATTRIBUTE GET
Repeater Health Text	ATTRIBUTE GET
Repeater Health Data	ATTRIBUTE GET
Transmit Collisions	ATTRIBUTE GET
Reset Repeater	ACTION
Execute Non-disruptive self Test	ACTION
Repeater Health	NOTIFICATION
Repeater Reset	NOTIFICATION
Group Map Change	NOTIFICATION
Resource Type ID Name	ATTRIBUTE GET
Resource Info	ATTRIBUTE GET
Group ID	ATTRIBUTE GET
Group Port Capacity	ATTRIBUTE GET
Port Map	ATTRIBUTE GET
Port Map Change	NOTIFICATION
Port ID	ATTRIBUTE GET
Port Admin State	ATTRIBUTE GET
Auto Partition State	ATTRIBUTE GET
Collisions	ATTRIBUTE GET
Readable Frames	ATTRIBUTE GET +
Readable Octets	ATTRIBUTE GET +
Frame Check Sequence Error	ATTRIBUTE GET +
Alignment Error	ATTRIBUTE GET +
Frame Too Long	ATTRIBUTE GET +
Short Events	ATTRIBUTE GET +
Runts	ATTRIBUTE GET +
Late Events	ATTRIBUTE GET +
Very Long Events	ATTRIBUTE GET +
Data Rate Mismatches	ATTRIBUTE GET +
Last Source Address	ATTRIBUTE GET +
Source Address Changes	ATTRIBUTE GET +
Auto Partitions	ATTRIBUTE GET
Port Admin Control	ACTION

Note: “+” indicates a statistic added via MIB extension

4.2 Installation, General Information

The Magnum SNMP agent is an option with the Magnum 3000X Stackable Concentrators. The SNMP embedded agent, Model 3000-MB, will be configured and tested as part of a Magnum 3000X stack or single unit at the factory when specified at the time of order. In order to satisfy network growth and changing network requirements, Magnum 3000X Stackable may also be upgraded in the field with the addition of a Magnum SNMP agent box such as Model 3000-AGT.

With either of the two agent implementations, the agent's operation and performance is the same. The selection of the desired version is entirely a function of user preference. For one Magnum 3000X stack (which may be from one to twenty units, and may be any combination of 3024, 3012, and 3000X units), only one SNMP agent is required, and only one SNMP agent may be in use at any given time.

4.3 Installing the Embedded Agent Board, "MB"

The embedded agent board, Model 3000-MB, is normally factory installed.

The procedure for installing the Magnum 3000-MB in the field is a straightforward but moderately complex process. (To avoid complex field installation and test procedures, it is recommended that a Magnum 3000-AGT agent box unit be chosen and added to the existing stack when a field upgrade from non-managed to embedded-agent-managed is desired.) The following step-by-step procedure should be followed to properly install the Magnum SNMP embedded agent board.

STOP!!!

**Be sure the power cord is unplugged
from the chassis before attempting to remove
and/or replace an RPM card.
Failure to do so may result in damage to the unit
and will void the warranty.**

Step 1. Remove Chassis Cover

There are 7 screws located on top and 3 on the top-front of the unit. Remove these screws. The chassis cover is easily lifted off the chassis base. (See Figure 5.3b).

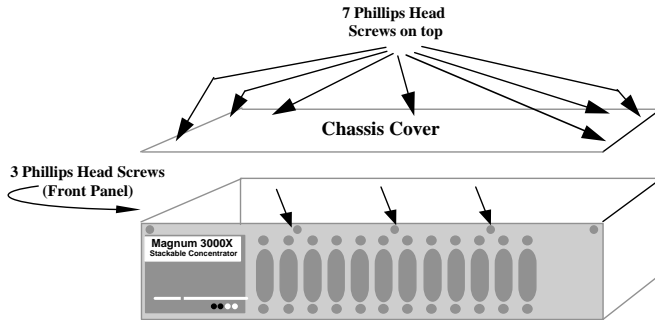

Figure 4.3a: Removing Magnum 3000X Chassis Cover

Caution: Be careful not to disturb the power supply.

Step 2. Insert the Agent Board

Looking down into the Magnum 3000X unit, as shown in Figure 4.3e, the Embedded Agent Board mounts on top of the other printed circuit boards in the left-rear

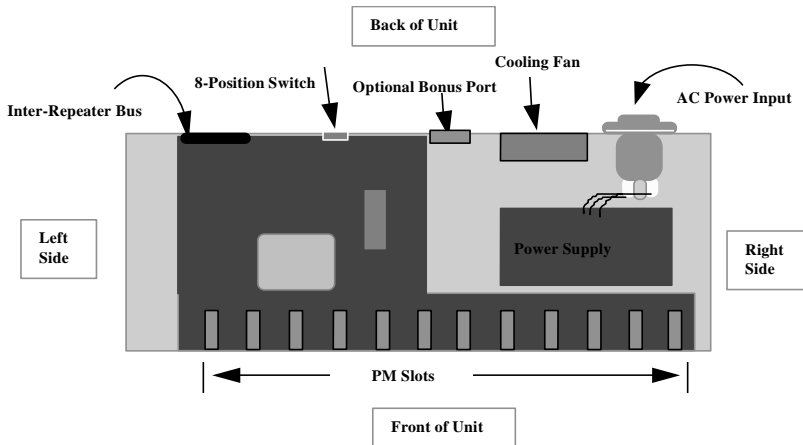

Figure 4.3b: Magnum 3000X, Top View with Chassis Cover Off

area of the unit. Three screws with stand-offs hold it firmly in place in the correct position.

The Magnum SNMP embedded agent daughter board, Figure 4.3f, connects into the DB-9 connector "P1" on the back of the Magnum 3000X unit with a cable, and it plugs into the main board and into the power supply with assorted cables. The exact type and number of cables and connectors for this installation varies depending upon the vintage of the 3000X unit being upgraded. Kits may be available from GCI's Spare Parts List with parts and instructions to suit the different unit revs. Consult with GCI Tech Support.



Figure 4.3c: Embedded Agent Board

Note: Since the 3000X base unit includes a cooling fan, adding an Embedded Agent in the 3000X does not create a marginal cooling situation.

Replace the chassis covers on the units, reversing the procedure in Step 1.

Step 3. Set Group # (Stack) Address

On the back of Magnum 3000X Concentrators is an eight-position DIPswitch. The first six positions are used to identify each unit in binary code as a Group # address. Switches 7 and 8 are not used.

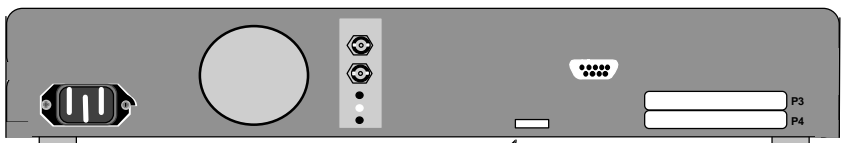

Eight (8) position dip switch.
 1 - 6 = Address of Repeater Unit (1-20)
 7 = Not used - Previously used to allow PC-based SNMP Agent
 8 = Not Used

Figure 4.3d: Magnum 3000X, Rear View

For managed stacks, the unit configured with the embedded SNMP agent in it should be set to the # 1 Group address. The "AGT" agent box unit, if used in a stack, has no Group # address itself. See also Table 4.3, "Group # Address Switch Settings".

From the perspective of the network manager, the Magnum SNMP agent board or box is not visible as a separate user or port. It cannot be disabled either accidentally or purposefully. This prevents the agent itself from being disconnected, causing an irreversible loss of control of the entire stack from the network manager.

Address\switch	1	2	3	4	5	6
1	on					
2		on				
3	on	on				
4			on			
5	on		on			
6		on	on			
7	on	on	on			
8				on		
9	on			on		
10		on		on		
11	on	on		on		
12			on	on		
13	on		on	on		
14		on	on	on		
15	on	on	on	on		
16						on
17	on					on
18		on				on
19	on	on				on
20			on			on

Table 4.3: Eight-Position DIP Switch Configuration Table

Notes:

- **The Group # Address is used by the network manager** to distinguish among the physical units that are combined (or grouped) in the stack to operate as one repeater managed by one SNMP agent. The NMS display will show the stack units arranged in sequence according to the Group #. (The SNMP standard defines the term "Group #" for data collection and control operations.)

It is desirable to use Group Address # 1 for the Magnum 3000X unit, which houses the embedded agent.

- **Switch # 7 is no longer used.** (This switch was used in older versions to specify a PC-based software agent).

- **Switch # 8 is not used.**

See Address Switch Settings, for further information on this topic.

4.4 Agent Configuration, Embedded Agent and Agent Box Versions

The SNMP Agent software resides in ROM chips on the hardware agent board. After power up, the software begins a number of tests that check the system for normal operations: CPU test, EPROM CRC test, DRAM test, Network Interface Controller test and NVRAM test.

During the configuration process, an ANSI compatible terminal or a PC running ANSI terminal emulation software should be connected (through a null modem cable) to the serial port "P1" located on the rear panel of the Magnum 3000 unit. The terminal characteristics should be set to: 9600 Baud, 8 bit data, no parity, 1 stop bit.

If the agent board (either embedded in a unit, or in a box by itself) is operating properly, the following (example) message will appear on the terminal screen:

```

Performing Self Diagnostics . . .                (pause for 30 to 60 seconds typically)
GarrettCom, Inc. Embedded Agent Version 02.05    (example)
Processor 3003 Controller 14 Ethernet Controller 30003003 (example)
Ethernet address 00 00 1A 18 0E 18 IP address 45.9.0.5    (example)
>

```

4.4.1 Automatic Agent IP Address Configuration.

At power up, the agent software program will search for an IP address in NVRAM. A legitimate IP address is set into the NVRAM at the factory, permitting the unit or stack when new to automatically go into operation as a stand-alone network.

For more complex networks where the IP address is to be set from a server on an existing network, set the NVRAM IP address to a blank using the procedure in "Function Listing, Address" below. Then, at power up when the agent software program does not find an IP address, it will try to get configuration information from a boot server by using the BOOTP protocol. If this attempt fails, it will try RARP protocol. This process may require up to one minute.

Next, the agent automatically determines the configuration of the Magnum 3000X stack by reading the group # addresses of all of the units in the stack. The stacked units, from one to twenty in number, which operate as one repeater, will have one repeater agent and its IP address. (Note that a group # address should be set for each unit by using switches on the back of each unit. See Section 5.3, Table 5.3.

4.4.2 Manual IP Address Configuration.

If the network does not support BOOTP or RARP, or if you need to manually change the agent's IP address to a user-specified address, it can be done from a terminal (see 4.4 above) connected to the serial port P1 on the back of the Magnum 3000X unit containing the embedded agent, or to P1 on the agent box.

From the top menu prompt **>**, type: **C {Cr}**.

On the terminal, the prompt will appear: **CFG>**

The agent configuration menu consists of the following commands:

ADDRESS
BOOTP
COMMUNITY
DISPLAY
GATEWAY
MANAGER
NAMESERVER
SUBNETMASK
EXIT

To see a command selection menu, type: **help {Cr}**.

On the terminal screen, a menu with command lines and the meaning of each command will appear:

A[DDRESS] [IP/ NAME]	IP address
B[OOTP] [IP/NAME]	Bootp Server
C[OMMUNITY] [# [NAME[S] [MANAGER....]]]	Communities access:
	S - Allow Set operations
	Managers - list of IP addresses and/or names
D[ISPLAY]	Display whole configuration
E[XIT]	Exit configuration
G[ATEWAY] [# [IP [SUBNETIP [MASKIP]]]]	Gateways
M[ANAGER] [# [IP/NAME [PORT] COMMUNITY]]	Managers
N[AMESERVER] [# [IP/NAME]]	Name Servers
S[UBNETMASK] [IP]	Subnet mask

Command or Function Listing**1. ADDRESS:****A[DDRESS] [IP/ NAME]**

The "Address" command is used to define and/or display an agent's IP address.

To set an IP address, type: **A [address value] {Cr}**

(Example: **>A 45.9.0.38 {Cr}**)

To display the current IP address, type: **A {Cr}**

2. BOOTP**B[OOTP] [IP/NAME]**

Used to define or display the IP address and/or name of your BOOTP server.

To set, type: **B [address value/name] {Cr}**

(Example: **>B 45.9.0.171**)

3. COMMUNITY**C[OMMUNITY] [# [NAME [S] [MANAGER....]]]**

Used to set the community string for GET and SET operations.

-- number of community. (Up to 10 different communities may be set)

S -- allow SET operations. (If you do not "S" this command, this community will allow only GET operations)

MANAGER -- the network manager IP addresses list, up to 10. (If the manager IP addresses list is not present in a command line, any network manager can communicate with this agent using this community string)

Example of two managers: **>C 3 MAGNUM S 45.9.0.122 45.9.1.3{Cr}**

To display community, type: **C {Cr}**

To delete community, type: **C [#] {Cr}**

3. DISPLAY

To display the whole configuration file, type: **D {Cr}**

Example: **>D {Cr}** (All configuration information will appear)

4. EXIT

To exit from the configuration menu, type **E {Cr}**

Example: **>E {Cr}**

5. GATEWAY**G[ATEWAY] [# [IP [SUBNETIP [MASKIP]]]]{Cr}**

Used to set the gateway IP address and mask. Up to 10 gateways may be set.

Example: **>G 3 45.9.0.112 255.255.255.0 255.0.0.0{Cr}**

6. MANAGER**M[ANAGER] [# [IP/NAME [PORT] COMMUNITY]]**

Used to set the number of network manager IP addresses, and the community to which TRAPS should be sent. Up to 10 managers may be set. If "PORT" is absent, then TRAPS are sent to port 162, as specified in RFC 1157. If "COMMUNITY" is absent, the community string "public" is used by default.

Example: **M 2 45.9.1.125 Magnum {Cr}**

7. SUBNETMASK**S[UBNETMASK] [IP]{Cr}**

To set IP mask, type: **S [mask value] {Cr}**

Example: **>S 255.255.255.0 {Cr}**

NOTE: After entering information using the commands above, to make the new configuration operative, exit from the configuration menu by typing: E {Cr}
If the agent's IP address has been changed, reset the Magnum 3000 (via a power down) to install the change.

After new subnet configuration information is set in operation, it will reside in NVRAM. Powering down the Magnum 3000 will not destroy it, and at power up the agent will read the configuration information from NVRAM and start operations with it.

4.4.3 Other Convenience Commands

From the top menu, one can also set the time and date. The time and date do NOT reside in NVRAM and will be lost at power down. **From the prompt, type:**
T [mm/dd/yy] [hh:mm] {Cr}

Example: **>T 11/12/93 11:45 {Cr}** sets the date and (military) time.

To display the version and Ethernet physical address, from the prompt, type: **V {Cr}**
 On the terminal, a message with version number and information about the processor, system controller, Ethernet controller, and physical Ethernet address will appear in response.

Example: **>V {Cr}**
Garrett Communication Embedded Agent Version 01.01
Processor 3003 Controller 13
Ethernet Controller 30003003 Ethernet address 00 00 1A 18 0E 05
>

5.0 TROUBLESHOOTING

All Magnum Ethernet products are designed to provide reliability and consistently high performance in all network environments. The installation of Magnum 3000X Stackable Concentrators is a straightforward procedure (see INSTALLATION, Section 3.6); the operation is also straightforward and is discussed in sections on each type of unit.

Should problems develop during installation or operation, this section is intended to help locate, identify and correct these types of problems. Please follow the suggestions listed below prior to contacting your supplier. However, if you are unsure of the procedures described in this section or if the Magnum 3000X product is not performing as expected, do not attempt to repair the unit; instead contact your supplier for assistance or contact GarrettCom, Inc. Customer Support.

5.1 Before Calling for Assistance

1. If difficulty is encountered when installing or operating the unit, refer back to the Installation Section of the applicable chapter of this manual. Also check to make sure that the various components of the network are interoperable.
2. Check the cables and connectors to ensure that they have been properly connected and the cables/wires have not been crimped or in some way impaired during installation. (About 90% of network downtime can be attributed to wiring and connector problems.)
3. Make sure that an AC power cord is properly attached to each Magnum 3000 unit. Be certain that each AC power cord is plugged into a functioning electrical outlet. Use the PWR LEDs to verify each unit is receiving power.
4. If the problem is isolated to a network device other than the Magnum 3000 product, it is recommended that the problem device be replaced with a known good device. Verify whether or not the problem is corrected. If not, go to Step 5 below. If the problem is corrected, the Magnum 3000 and its associated cables are functioning properly.
5. If the problem continues after completing Step 4 above, contact your supplier of the Magnum 3000 unit or if unknown, contact GarrettCom, Inc. by fax, phone or email (*support@garrettcom.com*) for assistance.

5.2 When Calling for Assistance

Please be prepared to provide the following information.

1. A complete description of the problem, including the following points:
 - a. The nature and duration of the problem;
 - b. Situations when the problem occurs;
 - c. The components involved in the problem;
 - d. Any particular application that, when used, appears to create the problem;
2. An accurate list of GarrettCom, Inc. product model(s) involved, with serial number(s). Include the date(s) that you purchased the products from your supplier.
3. It is useful to include other network equipment models and related hardware, including personal computers, workstations, terminals and printers; plus, the various network media types being used.
4. A record of changes that have been made to your network configuration prior to the occurrence of the problem. Any changes to system administration procedures should all be noted in this record.

5.3 Return Material Authorization (RMA) Procedure

All returns for repair must be accompanied by a Return Material Authorization (RMA) number. To obtain an RMA number, please use this URL - https://rma.garrettcom.com/rma/rma_request_noaccount.php to fill out the form. Please have the following information readily available:

Name and phone number of your contact person.
Name of your company / institution
Your shipping address
Product name
Serial Number (or Invoice Number)
Packing List Number (or Sales Order Number)
Date of installation
Failure symptoms, including a full description of the problem.

GarrettCom, Inc. will carefully test and evaluate all returned products, will repair products that are under warranty at no charge, and will return the warranty-repaired units to the sender with shipping charges prepaid (see Warranty

Information, Appendix A, for complete details). However, if GarrettCom, Inc., cannot duplicate the problem or condition causing the return the unit will be returned as:

No Problem Found.

GarrettCom, Inc. reserves the right to charge for the testing of non-defective units under warranty. Testing and repair of product that is not under warranty will result in a customer (user) charge.

5.4 Shipping and Packaging Information

Should you need to ship the unit back to GarrettCom, Inc., please follow these instructions:

1. Package the unit carefully. It is recommended that you use the original container if available. Units should be wrapped in a "bubble-wrap" plastic sheet or bag for shipping protection. (You may retain all connectors and this Installation Guide.)

CAUTION

Do not pack the unit in Styrofoam "popcorn" type packing material. This material may cause electro-static shock damage to the unit.

2. Clearly mark the Return Material Authorization (RMA) number on the outside of the shipping container.
3. GarrettCom, Inc. is not responsible for your return shipping charges.
4. Ship the package to:

GarrettCom, Inc.

47823 Westinghouse Dr.

Fremont, CA 94539

Attn.: Customer Service

APPENDIX A: WARRANTY INFORMATION

GarrettCom, Inc. warrants its products to be free from defects in materials and workmanship for a period of three (3) years from the date of shipment by GarrettCom, Inc.

During this warranty period, GarrettCom, Inc. will repair or, at its option, replace components in the products that prove to be defective at no charge other than shipping and handling, provided that the product is returned pre-paid to GarrettCom, Inc.

This warranty will not be effective if, in the opinion of GarrettCom, Inc., GarrettCom, Inc has damaged by misuse, misapplication, or as a result of service or modification other than the product.

GarrettCom, Inc. reserves the right to make a charge for handling and inspecting any product returned for warranty repair which turns out not to be faulty.

Please complete the warranty card as this acts as a product registration, and mail it to GarrettCom, Inc. within two weeks of your purchase.

APPENDIX B: Internal DC Power Supply Option**B1.0 SPECIFICATIONS - FOR MAGNUM 3000XS****Power Supply (Internal -48VDC Option)**

DC Power Connector: 3 terminals: “-“, “GND”, “+”

Input Voltage: 36 - 70 VDC

Power Consumption: Model **3000X**: 18-watt typical, 30 watts max.

Power Supply (Internal 24 VDC Option) for Industrial Applications

DC Power Connector: 3 terminals: “-“, “GND”, “+”

Input Voltage: 20 - 36 VDC

Power Consumption: Model **3000X**: 18 watt typical, 30 watts max..

Power Supply (Internal 125 VDC Option) for Power Substation Applications

DC Power Connector: 3 terminals: “-“, “GND”, “+”

Input Voltage: 120 - 160 VDC

Power Consumption: Model **3000X**: 18-watt typical, 30 watts max.

With the exception of the power supply, all specifications and functions of Magnum 3000X-48VDC, 24VDC and 125VDC models are identical to those listed in the main manual.

B2.0 -48VDC, 24VDC & 125VDC POWER OPTION, THEORY OF OPERATION

The -48VDC, 24VDC & 125VDC power options are designed using diodes inside on each DC power input line behind the two external power connection terminals, so that the power from an external source can only flow into the unit. This allows the 3000X to operate only whenever DC power is correctly applied to the two inputs. It protects the 3000X from incorrect DC input connections. An incorrect polarity connection, for example, will neither affect the 3000X or the internal power supply. Nor will it blow the fuse in the internal power supply.

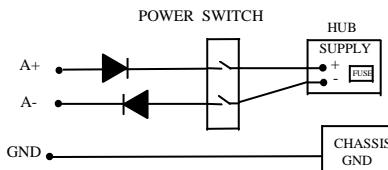

The manual power “On-Off” Switch (optional) is used for powering the unit on and off when it is placed into or taken out of service.

B3.0 APPLICATIONS FOR DC POWERED SWITCHES

Magnum 3000X’s are easily installed in a variety of applications where -48VDC, 24VDC & 125VDC power is used as the primary power source. The -48VDC, 24VDC & 125VDC power configuration provides an Ethernet networking solution utilizing a special power supply in hubs with a proven track record.

The -48VDC solution is particularly useful in the telecommunication industry, where it is common for facilities to operate on -48VDC power. Such companies include regular and wireless telephone service providers, Internet Service Providers (ISPs) and other communication companies. In addition, many high availability equipment services, such as broadcasters, publishers, newspaper operations, brokerage firms and other facilities often use a battery backup system to maintain operations in the event of a power failure. It is also frequently used for computer system backup, management and operations monitoring equipment.

The 24VDC & 125VDC solution are particularly useful in the Industrial environment, where it is common for facilities to operate on 24VDC or 125VDC power.

The 125VDC solution is mainly used in power utilities, such as electrical substations, electrical generating plants, etc. The 24VDC applications are mainly in the Industrial environment, such as factory floor, HVAC equipment, military equipment, etc.

B4.0 INSTALLATION

This section describes the installation of the -48 VDC, 24VDC & 125VDC power source leads to the -48 VDC, 24VDC & 125VDC power terminal block on the Magnum 3000X. (See figure at right).

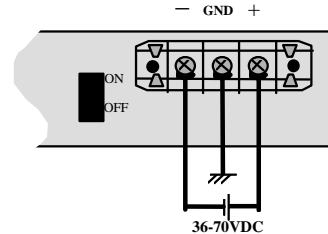

Figure B4.1: -48VDC Terminal Block on Magnum 3000X -48VDC

In this picture, the -48VDC terminal block on the Magnum 3000X is located on the rear of the unit and is equipped with three (3) screw-down lead posts. It is similar for 24VDC and 125VDC options on the 3000X. The leads are identified as negative (-), positive (+), and chassis ground (GND).

The actual connection procedure is very straightforward. Simply connect the leads to the Magnum unit, beginning with ground. Ensure that each lead is securely tightened.

Note: *The GND should be hooked up first. The 3000X unit has a floating ground, so the user may elect to Ground either + or = terminal to suit the customer's use.*

Before connecting hot lines to the Terminal Block of -48VDC, 24VDC or 125VDC, always use a digital voltmeter to measure the output voltage of the power supply and determine the lead, which is more "+ve potential". The more "+ve" voltage lead from 48V or -48V supply must be connected to the post labeled "+".

An ON-OFF manual switch is optional for DC power. This can be used to cut off power connections, and as a RESET for the Hub and / or SNMP Agent.

B4.1 UL Requirements

1. Minimum 14 AWG cable for connection to a Centralized DC power source.
2. Fastening torque of the lugs on the terminal block: 9-inch pound max.
3. Centralized DC Power Source cable securement, use at least four cable ties to

secure the cable to the rack at least 4 inches apart with the first one located within 6 inches of the terminal block.

B5.0 OPERATION

Operation of the Magnum 3000X with the optional -48VDC, 24VDC & 125VDC power supply is identical to that of the AC-powered models.

B6.0 ORDERING INFORMATION

To order the optional -48VDC power supply factory installed, add a suffix of “-48VDC” after the product’s standard model #. Example: **Magnum 3000X-48VDC**.

Similarly, to order the optional 24VDC or 125VDC industrial specific power supply factory installed, add a suffix of “-24VDC or “-125VDC” after the product’s standard model #. Example: **Magnum 3000X-24VDC or Magnum 3000X-125VDC**.

B7.0 TROUBLESHOOTING Please refer to Section 6.0

APPENDIX C: Internal DC Dual-Source Power Option

C1.0 SPECIFICATIONS - FOR MAGNUM 3000X CONCENTRATORS

Power Supply (Internal, -48VDC Dual-Source, model # Dual-Src-48V)

DC Power Connector: First Source: “A+”, “A-“, 2nd Source “B-“, “B+”

GND: Terminal for “earth” or ground wire connection to the hub chassis

Input: Two separate sources, each at 36 - 70 VDC

Power Consumption: Model **3000X**: 18-watt typical, 30 watts max.

Power Supply (Internal, 24VDC Dual-Source, model # Dual-Src-24V)

DC Power Connector: First Source: “A+”, “A-“, 2nd Source “B-“, “B+”

GND: Terminal for “earth” or ground wire connection to the hub chassis

Input: Two separate sources, each at 20 - 36 VDC

Power Consumption: Model **3000X**: 18-watt typical, 30 watts max.

Power Supply (Internal, 125VDC Dual-Source, model # Dual-Src-125V)

DC Power Connector: First Source: “A+”, “A-“, 2nd Source “B-“, “B+”

GND: Terminal for “earth” or ground wire connection to the hub chassis

Input: Two separate sources, each at 120 - 160 VDC

Power Consumption: Model **3000X**: 18-watt typical, 30 watts max.

With the exception of the dual DC input power connections and the power

supply, all specifications and configuration options for the Magnum 3000X -48VDC with this Dual-Source option are identical to those listed in the *Magnum 3000X's Installation and User Guide*, including Appendix B “Internal DC Power Supply Option”

C2.0 MAGNUM 3000X with -48VDC, 24VDC & 125VDC Dual-Source option

The 3000X Hub with the internal -48VDC, 24VDC & 125VDC Dual-Source power supply are designed for installations where a battery plant is the power source, and where two separate power sources are utilized in order to increase operational uptime and to simplify maintenance.

The functionality of the Magnum 3000X units with the -48VDC, 24VDC & 125VDC Dual-Source Option is identical to the standard AC-powered models. Refer to the main sections of this *Installation and User Guide* for a detailed description of the Magnum 3000X units and Configuration options.

C3.0 DUAL-SOURCE OPTION, THEORY OF OPERATION

The Dual-Source DC power option is designed using diodes inside of the chassis on each DC power input line. A diode is placed in each of the four input lines (behind the four external power connection terminals) so that power from an external source can only flow into the unit. This allows the unit to operate whenever DC power is correctly applied to either or both of the two inputs

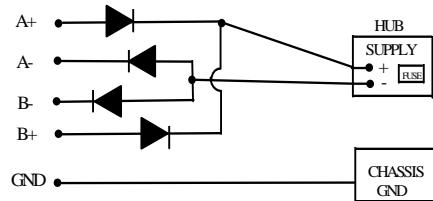

C4.0 FEATURES AND BENEFITS OF THE DUAL-SOURCE DESIGN

- The 3000X unit can receive power from either input, “A” or “B”. The hub will normally draw its power from the DC source with the highest voltage at a given time.
- The Switch unit will not allow power to flow from a higher voltage input to a lower voltage input, i.e. the two DC power sources are not mixed together by the hub.
- When one correct DC input is present, the 3000X will receive power if the other DC input is absent, or even if it is connected with reverse polarity or shorted or grounded.
- Reverse polarity connections, if they should accidentally occur on either input, will not damage the 3000X or power supply internally (nor will it blow the fuse in the internal power supply) because of the blocking action of the diodes. This is true even if one input connection is reversed while the 3000X is operating from the other source.

- e) The 3000X will not receive power (and will not work) when both inputs are simultaneously absent or are both incorrectly connected.

C5.0 INSTALLATION

This section describes the proper connection of the -48VDC, 24VDC & 125VDC dual source leads to the -48VDC, 24VDC, & 125VDC power terminal block on the Magnum 3000X (shown in Figure C5.0)

The -48VDC terminal block on the Magnum 3000X, as shown in Fig C5.0 is located on the right rear of the unit and is equipped with five (5) screw-down lead posts. The primary terminals are identified as positive (A+), negative (A-), and the secondary power terminals as negative (B-), positive (B+). The chassis “earth” or ground (GND), is a threaded post with a #6 nut. The dual source terminal block for 24VDC and 125VDC are similar.

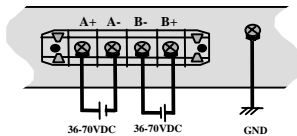

Figure C5.0: -48VDC Dual-Source, wiring connections to the External Terminal Block on a Magnum 48VDC with Dual-Source option

Note: The GND should be hooked up first. The 3000X unit has a floating ground, so the user may elect to Ground either + or = terminal to suit the customer’s use.

Before connecting to the Terminal Block of -48VDC, 24VDC or 125VDC, always use a digital voltmeter to measure the output voltage of the power supply and determine the lead, which is more “+ve potential”. The more “+ve” voltage lead from 48V or -48V supply must be connected to the post labeled “+”.

The connection procedure is straightforward. Simply connect the DC leads to the 3000X’s power terminals, positive (+) and negative (-) screws. The use of Ground (GND) is optional; it connects to the 3000X chassis. Ensure that each lead is securely tightened.

The 24VDC & 125VDC terminal block on Magnum 3000X is similar to that described in the -48VDC info above.

C5.1 UL Requirements

The following must be adhered to in order to conform to UL requirements:

1. *Minimum 14 AWG cable for connection to a Centralized DC power source.*
2. *Fastening torque of the lugs on the terminal block: 9-inch pound max.*
3. *Centralized DC Power Source cable securement, use at least four cable ties to secure the cable to the rack at least 4 inches apart with the first one located within 6 inches of the terminal block.*

C6.0 ORDERING INFORMATION

To order the optional Dual-Source -48VDC power supply factory installed, order “Dual-Src48V” as a separate line item following the product model.

Example: **Magnum 3000X-48VDC**

Dual-Src-48V for the regular dual-source model

or **Dual-Src48V-SWITCH** w/ ON-OFF manual switch

Similarly to order the optional “Dual –Source 24VDC” or “Dual-Source 125VDC”, order “Dual-Src24V” or “Dual-Src125V” as a separate line item following the product model

Example: **Magnum 3000X-24VDC or Magnum 3000X-125VDC**

Dual-Src24V for regular model with no ON-OFF switch

or **Dual-Src125V-SWITCH** for model with ON-OFF switch

C7.0 OPERATION

Operation of the Magnum 3000X units with -48VDC, 24VDC & 125VDC Dual Source options is identical to that of the standard models.